




# FSCN ANNUAL REPORT 2014



FSCN

PART OF  MID SWEDEN UNIVERSITY

**FSCN IN PARTNERSHIP WITH**



**Vetenskapsrådet**



Forskningsrådet för miljö, areella näringar  
och samhällsbyggnad, Formas



**KK-stiftelsen** ><



**Energimyndigheten**


*En investering för framtiden*



EUROPEISKA  
UNIONEN  
Europeiska  
regionala  
utvecklingsfonden



Sensible  
Things that  
Communicate

PART OF  MID SWEDEN UNIVERSITY

**FSCN Annual Report 2014**

Diarienummer: MIUN 2015/955

Cover picture fotografaper: Tina Stafren

Feature: Processing of graphene for paperbased supercapacitors in the laboratory at FSCN

Print: Mid Sweden University

## TABLE OF CONTENTS

1.	Introduction	4
2.	Doctoral and Licentiate Thesis	6
3.	FSCN in numbers	8
4.	FSCN and STC - our KK research environment	11
5.	Research projects within FSCN 2014	12
6.	Conferences	14
7.	Awards	16
8.	FORIC	17
9.	PhD Exams	20
10.	A selection of researchers within FSCN 2014	40

## I. INTRODUCTION

### **Research to transform the industrial ecosystem**

Mid Sweden University is located in a region with large forests and strong forest-based industry. Our multi-disciplinary research centre FSCN, Fibre Science and Communication Network, develops knowledge and technologies that improve the profitability of the industry and open new business opportunities for sustainable forest-based bio-materials.

Our aim is to help industry to improve profitability by means of better efficiency in the use of energy and raw materials in their processes. In the same way, we support the development of new products that can be integrated in existing manufacturing systems or rely on the core competences of the industry. Environmentally-friendly manufacturing technology for high-yield pulps, the physical properties of paper and the integration of functionality in paper products are our key competences. Our research is one of the drivers for renewal of the industrial ecosystem in our region. We steer our research in close collaboration with the forest industry and the allied industries.

We work on improving the profitability of today's paper industry, and on finding new ways to use forest and wood fibres. We engineer materials that are extracted from the forest industry material flows, and then further refined to provide sustainable alternatives to e.g. plastics. We also develop ways to use wood fibres, paper and board in new ways, for example in three-dimensional packaging structures, paper solar cells and light-weight structural composites from fibre-based materials.

### **Three research areas in focus**

1. Resource efficient forest industrial production and bio-economy. We focus on process technology, system design and new products. High yield pulp (HYP) is produced at a yield over 85% by means of mechanical or combined chemical and mechanical unit processes. We research wood-based fuels, chemicals and side streams in the chain from forest to paper products. We also develop promising technologies for sustainable sequestering of metals from industrial and other water circulations.
2. Renewable energy systems through large functional surfaces. We study new applications and functionalities for large surfaces such as paper. We integrate paper technology with materials physics and design as well



as electronics. The research team behind Kinetic Energy Storage of Paper-Based Supercapacitors (KEPS) has demonstrated that graphene-coated paper provides inexpensive and high-efficiency supercapacitors that have promising automotive applications.

3. New cellulosic materials. We work on new fibre materials, natural polymers and paper composites using surface and colloid engineering.

FSCN is a part of the university's KK research environment, financed by the Knowledge Foundation. We are more than 70 researchers and co-operate closely with the research centre STC – Sensible Things that Communicate at Mid Sweden University. FSCN was established in 1999.

This report summarizes the results of our research during 2014.

Sundsvall, April 2015

Kaarlo Niskanen  
FSCN Research Director



## 2. DOCTORAL AND LICENTIATE THESIS 2014

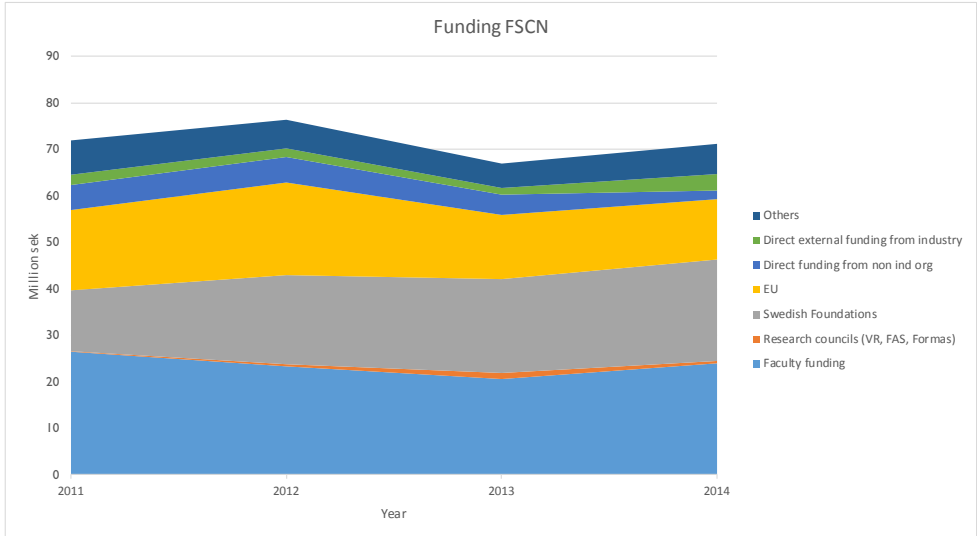
- Enberg, Sofia; *"Storage of Hydrogen Peroxide Bleached Mechanical Pulp; Reduction in Reflectance over the Visible Spectrum"*, Mid Sweden University, Doctoral Thesis ISSN 1652-893x:207 (2014)
- Wallin, Erika; *"The Scents of Nature: Identification and Synthesis of Bioactive Compounds used in Insect Communication"*, Mid Sweden University, Doctoral Thesis ISSN 1652-893x:200 (2014)
- Svanedal, Ida; *"Fundamental Characterization and Technical Aspects of a Chelating Surfactant"*, Mid Sweden University, Doctoral Thesis ISSN 1652-893x:179 (2014)
- Åslund, Pär; *"On Failure Mechanisms and Strength Predictions in Corrugated Board Structures"*, Mid Sweden University, Doctoral Thesis ISSN 1652-893x:190 (2014)
- He, Jie; *"Gasification-based Biorefinery for Mechanical Pulp Mills"*, Mid Sweden University, Doctoral Thesis ISSN 1652-893x:188 (2014)
- Zasadowski, Darius; *"Selective Separation Of Wood Components In Internal Process Waters Originating From Mechanical Pulping"*, Mid Sweden University, Doctoral Thesis ISSN 1652-893x:184 (2014)
- Göransson, Kristina; *"Internal Tar/CH<sub>4</sub> Reforming in Biomass Dual Fluidised Bed Gasifiers towards Fuel Synthesis"*, Mid Sweden University, Doctoral Thesis ISSN 1652-893x:187 (2014)
- Fagerlund-Edfeldt, Amelie; *"Naturally Occuring Phenols with Antioxidant, Antifungal and Anti-Browsing Activity"*, Mid Sweden University, Doctoral Thesis ISSN 1652-893x:198 (2014)
- Öhlund, Thomas; *"Metal Films for Printed Electronics: Ink-Substrate Interactions and Sintering"*, Mid Sweden University, Doctoral Thesis ISSN 1652-893x:210 (2014)
- Afewerki, Samson; *"Development of Catalytic Enantioselective C-C bond-forming and Cascade Transformation by merging Homogeneous or heterogeneous Transition Metal Catalysis with Asymmetric aminocatalysis"* Mid Sweden University, Doctoral Thesis ISSN 1652-893x:206 (2014)

- Andres, Britta; *"Paper-based Supercapacitors"*, Mid Sweden University, Licentiate thesis ISSN 1652-8948:112 (2014)
- Boija, Susanne; *"On Metal Ion Chelates and Conditional Stability Constant Determination: Method Development and Selective Ion Flotation of Chelating Surfactants"*, Mid Sweden University, Licentiate Thesis ISSN 1652-8948:111 (2014)
- Osong Henshaw, Sinke; *"Mechanical Pulp Based Nano-ligno-cellulose: Production, Characterisation and their Effect on Paper Properties"*, Mid Sweden University, Licentiate Thesis ISSN 1652-8948:109 (2014)

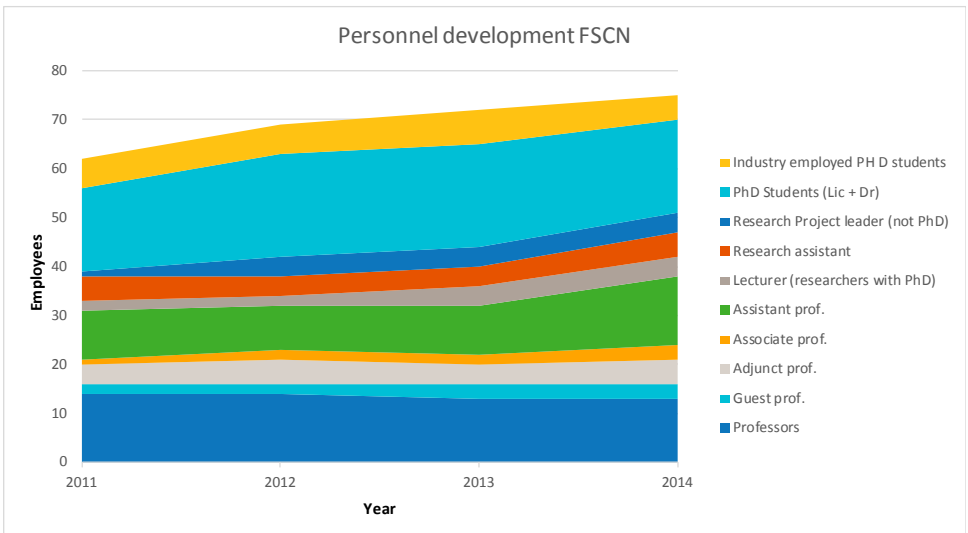


### 3. FSCN IN NUMBERS

**Figure 3.1 Funding (MSEK)**



**Figure 3.2 Personnel development**



## Promotions and new employees 2014

Björn Lindman, new visiting professor in chemical engineering.

### Master by Research

We offer a programme called Master by Research in Chemical Engineering. The Master by Research programme targets those who are highly motivated to develop skills and knowledge for a future career in academic, industrial or public R&D. This is also an excellent preparation for postgraduate studies.

### Postgraduate studies

Postgraduate studies withing FSCN are mainly in the subjects Chemistry, Chemical Engineering, Engineering Physics and Mathematics. The licentiate degree is 120 hp (approx 2 year full time studies) and the doctoral degree is 240 hp (approx 4 year full time studies).



*Björn Lindman, new visiting professor in Chemical Engineering together with professor Magnus Norgren and professor Håkan Edlund.*

**Table 3.1 Doctoral degree, Licentiate degree and Master degree**

Year	2011	2012	2013	2014
Doctoral degrees	1	4	3	10
Proceeded to external position	1	1	4	5
Licentiate degrees	2	4	3	3
Master degrees	5	1	0	1

**Table 3.2 Publications**

Year	2011	2012	2013	2014
Article in Journals	45	59	27	44
Conference Paper or Proceedings	19	15	19	26

**NPPRJ – Nordic Pulp and Paper Research Journal**

NPPRJ is an international scientific journal covering science and technology in the area of wood or bio-mass constituents, pulp and paper including new fibre-based materials, recovery and by-products from pulping processes, bio-refining and energy issues. The journal is run as a project with five Swedish, four Finnish and one Norwegian University. Appointed publisher is Per Engstrand at Mid Sweden University. The journal is published quarterly in March, June, September and December. Since the journals start-up in 1986 NPPRJ has endeavoured to publish peer-reviewed articles in the field of pulp and paper science of direct relevance to the forest products industry and of the highest possible scientific quality.

**Open Seminars called *Forskning möter Näringsliv***

Last year FSCN's seminar serie *Forskning möter Näringsliv* (Research meets business) continued in collaboration with BioBusiness Arena, Åkroken Science Park. The aim with these open seminars are to provide inspiration and knowledge about business development from industrial leaders and entrepreneurs. Understanding market trends and global economy are important for success in the applied research and new business creation that we pursue.

**2014 Guest seminars**

- Jonas Mårtensson, SCA Timber AB
- Ola Schultz-Eklund, Holmen
- Jon Sintorn, Permobil
- Thaddeus Maloney, Aalto University
- Gustav Tibblin, Södra skogsägarna
- Magnus Hall, Holmen
- Jan Åström, Munksjö



## 4. FSCN AND STC – OUR KK RESEARCH ENVIRONMENT

Mid Sweden University is one of three higher education institutions in Sweden that have been selected KK environments by the Knowledge Foundation (Swedish: KK-stiftelsen). The KK Research Environment aims at developing co-producing higher education institutions with profiled research.

### **Research with an industrial cooperation for transformation**

Within the KK Research Environment, we support renewal and innovativeness in the forest and IT industry. Two of our research centres cooperate interdisciplinary in the KK Research Environment: STC and FSCN. Our long-term aim for the environment is described in the TIE vision – Transforming the Industrial Ecosystem. The transformation is important for the forest industry that needs new products. IT, on the other hand, is an engine of growth that creates completely new products and services. By connecting these two lines of business, we create an industrial ecosystem with exciting prospects. In many of our projects, coproduction is central, which means that the project members are both from academia and the industry.

### **Transforming the Industrial Ecosystem**

- See possibilities from a global perspective
- Use information technology as a facilitator
- Adjust to a changing surrounding
- Provide industrial competences and skills
- Profiling of the most exciting opportunities



*Hans-Erik Nilsson, Dean and coordinator for the research environment at Mid Sweden University.*

## 5. RESEARCH PROJECTS WITHIN FSCN 2014

Research project	Project leader
Advanced high yield pulp for paperboard	Gunilla Pettersson
Bio2Fuels 2030	Wennan Zhang
Blixtsintring	Mattias Andersson
Boendes behov och värdering av uthålliga och energieffektiva bostäder	Lena Lorentzen
COAT - forskningsprojekt om funktionella papper	Håkan Olin
Compac - Plasticized lignocellulosic composites for packaging applications	Bo Westerlind
e2mp - Energy efficiency in mechanical pulping (e2mp) Bat 2012, Chip pre-treatment DD-refining, Efficient LC-refining, Pre-treatment strategies in high yield pulping, Refining of softened TMP fibres, Chiprefining efficiency, Fibre development models, Pre-study advanced HYP for paperboard, Maximized fibre wall swelling, Quantifying mechanical treatment during chipping, Effektiv CTMP framställning, Fix the Mix, HC/ LC raffinering, Homogenitet och heterogenitet, Kaviation, Optimerad energieffektivitet, MW-behandling, Save, Tillsats av kemikalier i CD raffinör; e2ctmp, e2mp-rp, e2mp-i, e2mp-ox	Per Engstrand
Examining the wood chipping process	Per Gradin
Fibre network design: Applications to hygiene products	Tetsu Uesaka
Fore - Forest as a resource	Erik Hedenström
Foric - Forest as a resource industrial research college	Per Engstrand
Högox - Highly selective electrocatalysts for anodic oxidation	Joakim Bäckström
KEPS - Paper-based supercapacitors	Sven Forsberg
Light-weight structural composites from fibre-based materials	Tetsu Uesaka
LignoFuel	Armando Córdova
LiON - Cost effective silicon-carbon composite anodes for lithium-ion batteries in automotive applications	Joakim Bäckström
Miljöhorisont 2020	Erik Hedenström
Modifying the wood chipping process	Per Gradin
Modulit - monolitiskt integrerade energilagringmoduler	Sven Forsberg
Morphology studies on future biocomposite	Christina Dahlström
Paper solar cells	Håkan Olin
Smart street lights	Håkan Olin
Svenskt förgasningscenter	Wennan Zhang
Tungmetallsbindande tensider	Magnus Norgren
Wood and fibre mechanics	Torbjörn Carlberg



## 6. CONFERENCES

### BUSINESS INNOVATION DAY 2014

In October 2014 we arranged the conference Business Innovation Day in Sundsvall together with the research centre STC and the innovation clusters BioBusiness Arena and Fiber Optic Valley. The companies could send in challenges and there were small workshops between researchers and companies to discuss solutions for the different challenges.

Companies who challenged our researchers 2014 was; Cosmomind, Energidalen, ICT Networks, In Situ, Mondi, Norrporten, Permobil, RagnSells, SCA, SSG and Sundsvalls Kommun. Many of the discussions led to new research projects and co-operations between the companies and Mid Sweden University.

### SCIENCE INNOVATION DAY 2014

In October we also arranged the big science and innovation conference Science & Innovation Day in Sundsvall together with BioBusiness Arena, Fiber Optic Valley and Åkroken Business Incubator. It was a unique venue for industry and researchers to meet and exchange knowledge and ideas.





The conference consisted of presentations from the speakers Andreas Gyllenhammar, Sweco, Daniel Söderberg, KTH and Annika Steiber, Chalmers.

In addition, researchers from STC and FSCN presented the latest research in an exhibition together with short highlights from the research results. Science & Innovation Day is a perfect opportunity to make new contacts and exchange ideas. Visit our YouTube-channel and you will find all the lectures from the day, [www.miun.se/fscn](http://www.miun.se/fscn).



### **A busy conference week**

Week 42 is a big conference week in Sundsvall. We arranged the conferences together with Sundsvall 42. The week began with the Business Innovation Day and the Science & Innovation Day. The conference week continued with presentations and workshops with a focus on service and business development in a digital society. The week ended with gaming for the somewhat younger audience.

These conference days will be arranged annually and present the research of FSCN and STC together with the innovation clusters. The goal is to contribute to regional development. Welcome to join us next time!

## 7. AWARDS

The Arne Asplund Mechanical Pulping Award 2014 winner was Professor **Per Engstrand**. The Arne Asplund Mechanical Pulping Award promotes the development of new technology for the manufacture of high-yield pulp. It is awarded to a person in recognition of outstanding achievement in research and development of mechanical pulping technology. Professor Per Engstrand has been active in the field of mechanical and chemimechanical pulping during his whole professional career. He graduated from KTH in 1980 as a M Sc in Chemical Engineering. He received his Licentiate of Engineering Degree in 1984 and became professor at Mid Sweden University in 2007.

Alf de Ruvo Foundation awards scholarships to researchers within the sphere of cellulose fibre-based materials and 2014 the scholarship was granted for **Christina Dahlström**. Christina graduated from KTH with a M Sc in Chemical Engineering and presented her doctoral thesis in Chemical Engineering at Mid Sweden University, Sundsvall, in 2012. Christina spent her scholarship at Stanford University, California, USA for six months during 2014 and 2015.

**Sinke Henshaw Osong** was awarded the ERGS Keith Kirkpatrick Award 2014. Sinke received his Licentiate of Chemical Engineering in 2014. He is now a PhD student at Mid Sweden University.





## 8. FORIC

FORIC (Forest as a Resource industrial research college) is our new industrial graduate school for PhD students from participating companies. FORIC is financed by the Knowledge Foundation and is part of our KK research environment at Mid Sweden University. 14 graduate students have now started their research.

FORIC is a graduate school in close cooperation with the business companies in Sweden where graduate students will increase their competitiveness. Academia and industry will benefit from interacting with each other.


Today biorefineries have become an important way to refine forest resources and develop the industries in a sustainable direction. But not even the really big companies can handle all the processes around the technology used in a biorefinery by themselves. Therefore optimizing the chain from forest to finished product requires collaboration between different companies in the forest industry and other companies close to forest industries, such as logistics, recycling, waste, energy etc. 30 researchers and professors from different disciplines at Mid Sweden University will be a part of the research graduate school.

Ongoing research projects and researchers from the different companies are presented in the following table. Read more about FORIC on the website [miun.se/foric](http://miun.se/foric).



*The PhD students in FORIC together with their supervisors and company representatives.*

Research project in FORIC	Researcher	Company
Wood preservative treatment and modification techniques; identification, evaluation and assessment of barriers and key success factors for large-scale commercialization	Jonas Johansson	SCA Timber AB
New use for bio-sludge from pulp and paper industries	Robert Norgren	Ragn-Sells AB
Methane measurement system and analysis	Bakhran Gaynullin	Sense Air AB
Technical and economical systems modelling of a mechanical pulping based bio refinery	Alexander Hedlund	Frontway AB
Improved fines material control	Mathias Lundberg	Pulpeye AB
Modified fibre process for improved final product properties	Hafizur Rahman	SCA Forest products AB
Integrated energy solutions	Anna-Karin Stengard	Sundsvall Energi AB
Industrially feasible methods for production of nanocellulose for chemical pulps	Carl Moser	Valmet AB
Cost-effective nanolignocellulose as substitute for CMC in multi-layer fibre applications	Sinke Henshaw Osong	MoRe Research and MIUN
Connecting High Yield pulp properties with functional product properties	Olof Ferritsius	Stora Enso and MIUN
Inline calorimetry based on multi wavelength x-ray analysis	N.N.	Mantex AB
Development of a domestic forest based tanning agent	Mats Paulsson	Sylvestris AB
Fibrillar chemical pulp fines to enhance paper board strength	Elisabeth Björk	Innventia AB
Efficient wood supply logistics adopted to combinates including modern saw mills and bio refineries	Magnus Larsson	Skogforsk/Stiftelsen skogsbrukets forskningsfond



*FSCN is a multi-disciplinary research centre at Mid Sweden University. We work on improving the profitability of today's paper industry, and on finding new ways to use the fibres from the forest. We engineer materials that are extracted from the forest industry material flows, and then further refined to provide sustainable alternatives to e.g. plastics. We also develop ways to use wood fibres, paper and board in new ways, for example in three-dimensional packaging structures and functionalities.*

## 9. PHD EXAMS 2014

### DOCTORAL THESIS

#### **Storage of hydrogen peroxide bleached mechanical pulp; Reduction in reflectance over the visible spectrum**

The objective of this thesis is to determine possible causes of the darkening of hydrogen peroxide bleached mechanical pulp over the visible spectrum and their relative contributions. It focuses on both process conditions and the composition of the pulp and the dilution water, including additions or losses of material along the process line from the bleach tower to the paper machine. A mapping of the optical properties of the pulp along the process showed that the fine fraction of the pulp darkened more than the long fibre fraction. Simulation of retention times of different fractions showed that the main part of the fine material is retained in the paper within a few hours, a small part might circulate for considerably longer time and may therefore be strongly coloured.

Storage trials were mainly performed using a hydrogen peroxide bleached mechanical pulp intended for SC paper made of Norway spruce (*Picea abies*), sampled on one occasion and stored in a freezer. Unwashed or well-washed pulp was stored in distilled water or in different process waters. Some complementary trials were included, e.g. unbleached pulp.

Time and temperature were the process variables that gave the strongest darkening of the pulp, as expected, both in a clean and a more process-like system, whereas pH only had an effect in the presence of process waters; the highest brightness stability was seen at a pH around 5.5–6.0. The darkening was due to an increase in the light absorption coefficient ( $k$ ) beginning at short wavelengths, but after longer storage times the increase in  $k\lambda$  also became noticeable at longer wavelengths. The colour (CIE  $L^*$ ,  $a^*$ ,  $b^*$ ) of the



Dr. Sofia Enberg

Supervisor  
Professor Per Engstrand

Ass. Supervisors  
Magnus Paulsson, Mats Rundlöf

pulp changed towards red and yellow, initially more towards red and then more towards yellow. These changes were clearly visible.

Washing of the bleached pulp made it less sensitive to storage; possibly due to the removal of extractives, lignin-like substances, metals and pulp fines. This washing had little effect before storage and the amount of material removed was small. The pulp darkened more when stored in process waters compared to distilled water. Apart from fibres, most of the colour was associated with pulp fines or filler but some colour was also found in the dissolved and colloidal fractions. At an increased pulp consistency, the increase in  $k_{460}$  was smaller. Storage in white water from the paper machine gave extensive discolouration with a shoulder in the absorption spectrum around 550–650 nm, which increased with time. The addition of ferric ions increased the light absorption coefficient during storage, but could not explain the increased absorption at 550–650 nm nor could it be the only cause of the darkening in the mill system. A cationic basic violet dye gave a shoulder in the absorption spectrum similar to that of the mill system, but the absorption of the dye did not increase during storage. Model calculations indicate, but do not prove, that ferric ions together with violet and red dyes could have played a major, but not exclusive role in the colour observed in the mill system after storage. The darkening not accounted for, at longer wavelengths and around 550–650 nm, is suggested to be related to fines and fillers including dissolved and colloidal substances associated with these particles.

A method to produce representative sheets for determination of optical properties of mechanical pulps was developed. The new method makes it possible to follow changes in light absorption and light scattering coefficients over the visible range of wavelengths. It is approximately six times faster than standard methods, reduces the risk of additional darkening of the sample and can be used with small pulp quantities.

The deviation from the expected linear behaviour of the light scattering coefficient,  $s$ , at wavelengths corresponding to strong light absorption has been studied using the Kubelka-Munk model and the angular resolved DORT2002 radiative transfer solution method. The decrease in  $s$  could not be explained by errors introduced in the Kubelka-Munk modelling by anisotropic scattering.

*Mid Sweden University Doctoral Thesis ISSN 1652-893x:207, ISBN 978-91-87557-91-0 (2014)*



## DOCTORAL THESIS

### The Scents of nature: Identification and synthesis of bioactive compounds used in insect communication

Pest insects cause great financial losses in the forest and food industry every year. To fight these pests industries have used insecticides, which are sometimes harmful to nature and humans. One potential way of avoiding insecticides is the use of integrated pest management based on insect communication, which would offer species-specific methods for protecting forest and food resources. Insects use chemicals known as semiochemicals for both intra- and interspecies communication. By learning how insects use these semiochemicals to talk to each other, we can eavesdrop and mimic their communication for our benefit. One research area dealing with these questions is chemical ecology, which is an interdisciplinary area as knowledge in chemistry and biology is required. Collaborations between groups within and outside of Sweden are essential in order to make progress in this field of research.

This thesis presents the identification and synthesis of semiochemicals from several insect species, most of which are considered to be pests. Synthesized compounds have been sent to collaboration partners around Sweden and Europe for biological evaluations.

Studies of the African butterfly, *Bicyclus anynana*, have unravelled particular biological phenomena that may aid in the understanding of the *Bicyclus* genus, though recognizing individual species variation is crucial. In 2008, the putative male sex pheromone of *B. anynana* was determined to consist of three compounds: hexadecanal, (Z)-9-tetradecenol and 6,10,14-trimethylpentadecan-2-ol, and the specific stereoisomer for 6,10,14-trimethylpentadecan-2-ol has been determined in this thesis. The ratio of 6,10,14-trimethylpentadecan-2-ol and the corresponding ketone were



Dr Erika A. Wallin

Supervisor  
Professor Erik Hedenström

Ass. Supervisor  
Professor emeritus Hans-Erik  
Högberg



investigated for seventeen *Bicyclus* species (including *B. anynana*) that live in overlapping regions in Africa. The stereochemistry was determined for most of the species and may provide a way to chemically distinguish them.

The orchid bees, *Euglossa* spp, are important pollinators of many orchids in Central America. Insight about pollination and conservation of endangered orchid species may be possible by gathering more information about the *Euglossa* genus. Males of the *Euglossa* genus have pouch-like structures on their hind legs where they store compounds collected from their surroundings. 6,10,14-Trimethyl-pentadecan-2-one is a common component of leg extracts from *Euglossa imperialis*, *E. crassipunctata* and *E. allosticta*, the specific stereochemistry of which has been determined in this thesis. Another, different compound was found in high amounts in *E. viridissima* and its structure has been elucidated; several synthetic pathways are under investigation to obtain the target compound.

Bed bugs (*Cimex lectularius* and *C. hemipterus*) are an ectoparasite that feed on human blood, and the number of reported infestations of these parasites has increased considerably during the last decade. Two 5th instar nymph-specific compounds, 4-oxo-hexenal and 4-oxo-octenal, were identified and synthesized.

Utilizing domestic dogs (*Canis lupus familiaris*) in the identification of bed bug infestations has become popular during recent years. Their training is usually conducted using live bed bugs; however, this thesis describes an alternative method of teaching dogs to find infestations. This alternative method is based on synthetic compounds and dogs trained in this manner have achieved a high positive indication rate.

Two species of the tiny, Acacia leaf-eating insect pests in Australia known as thrips, *Kladothrips nicolsoni* and *K. rugosus*, have been investigated by means of larval extracts and have been shown to contain large amount of (Z)-3-dodecenoic acid which was synthesized and tested in bioassays.

Fruit flies are common pests on fruit in almost every private household. Even though fruit flies have been investigated extensively, their chemical communication has not been completely elucidated. (Z)-4-undecenal was identified as a compound emitted by females, it was synthesized in high stereoisomeric purity and evaluated in biological assays.

*Mid Sweden University Doctoral Thesis ISSN 1652-893x:200; ISBN 978-91-87557-84-2 (2014)*

## DOCTORAL THESIS

### Fundamental characterization and technical aspects of a chelating surfactant

The purpose of this study was to investigate the fundamental characteristics of a chelating surfactant in terms of solution behaviour, chelation of divalent metal ions, and interaction in mixtures with different foaming agents and divalent metal ion, as well as examining its prospects in some practical applications. Chelating surfactants are functional molecules, with both surface active and chelating properties, which are water soluble and therefore suitable for chelation in many aqueous environments. The dual functionality offers the possibility to recover the chelating surfactant as well as the metals.

The DTPA (diethylenetriaminepentaacetic acid)-based chelating surfactant 4-C<sub>12</sub>-DTPA (2-dodecyldiethylenetriaminepentaacetic acid) was synthesized at Mid Sweden University. In the absence of metal ions, all eight donor atoms in the headgroup of 4-C<sub>12</sub>-DTPA are titrating and the headgroup charge can be tuned from +3 to -5 by altering the pH. The solution properties, studied by surface tension measurements and NMR diffusometry, were consequently found strongly pH dependent. pH measurements of chelating surfactant solutions as a function of concentration was used to extract information regarding the interaction between surfactants in the aggregation process.

Small differences in the conditional stability constants (log K) between the coordination complexes of DTPA and 4-C<sub>12</sub>-DTPA, determined by competition measurements utilizing electrospray ionization mass spectrometry (ESI-MS) indicated that the hydrocarbon tail only affected the chelating ability of the headgroup to a limited extent. This was further confirmed in hydrogen peroxide bleaching of thermomechanical pulp (TMP) treated with 4-C<sub>12</sub>-DTPA.



Dr Ida Svanedal

Supervisor  
Professor Håkan Edlund

Ass. Supervisor  
Professor Magnus Norgren

Interaction parameters for mixed systems of 4-C<sub>12</sub>-DTPA and different foaming agents were calculated following the approach of Rubingh's regular solution theory. The mixtures were also examined with addition of divalent metal ions in equimolar ratio to the chelating surfactant. Strong correlation was found between the interaction parameter and the phase transfer efficiency of Ni<sup>2+</sup> ions during flotations. Furthermore, a significant difference in log K between different metal complexes with 4-C<sub>12</sub>-DTPA enabled selective recovery of the metal ion with the highest log K.

The findings in this study contribute to the understanding of the fundamental characteristics of chelating surfactants, which can be further utilized in practical applications.

*Mid Sweden University Doctoral Thesis, ISSN 1652-893x:179; ISBN 978-91-87557-39-2 (2014)*

## DOCTORAL THESIS

### On failure mechanisms and strength predictions in corrugated board structures

Corrugated board is a paper-based sandwich material mainly used in transport and storage packaging. An important requirement of a corrugated board box is its stacking strength. Under stacking conditions, the loading of the side panels in the box will be dominated by edge-wise compression. The aim of this work is to improve strength predictions and aid the design of enhanced packaging solutions by investigating the failure mechanisms in corrugated board panels loaded in edge-to-edge compression.

The thickness changes in edge-wise compression loaded corrugated board panels are quantified experimentally using a digital image analysis technique. The results show that significant thickness reductions of the panel occur in the post-buckling regime. The reduction in thickness is found to be small near the edges and large near the centre of the panel. To further investigate the failure mechanisms associated with the thickness reductions, corrugated panel samples are compressed in the thickness direction while using X-Ray computed tomography. Obtained images of the internal structure show signs of local collapse and delamination zones in the core material at moderate relative thickness reductions. To numerically predict the edge-to-edge strength of corrugated board panels a finite element model is developed. The structure of core is modeled using both a linear-elastic material model and a gradient enhanced damage model. The gradient enhanced model is able to describe material degradation due to diffuse damage (such as delamination). Both the linear-elastic material model and the gradient enhanced damage model describe the general behavior of the buckling panel well but the gradient enhanced damage model gives better agreement with experimentally measured strain fields and predicts panel strength more accurately.

*Mid Sweden University Doctoral Thesis ISSN 1652-893x:190; ISBN 978-91-87557-62-0 (2014)*



Dr Pär Åslund

Supervisor  
Professor Per Isaksson

Ass. Supervisor  
Professor Per Gradin

## DOCTORAL THESIS

### Gasification-based biorefinery for mechanical pulp mills

The modern concept of “biorefinery” is dominantly based on chemical pulp mills to create more value than cellulose pulp fibres, and energy from the dissolved lignins and hemicelluloses. This concept is characterized by the conversion of biomass into various bio-based products. It includes thermochemical processes such as gasification and fast pyrolysis. In thermo-mechanical pulp (TMP) mills, the feedstock available to the gasification-based biorefinery is significant, including logging residues, bark, fibre material rejects, bio-sludges and other available fuels such as peat, recycled wood and paper products. On the other hand, mechanical pulping processes consume a great amount of electricity, which may account for up to 40% of the total pulp production cost. The huge amount of purchased electricity can be compensated for by self-production of electricity from gasification, or the involved cost can be compensated for by extra revenue from bio-transport fuel production.



Dr Jie He

Supervisor  
Professor Per Engstrand

Ass. Supervisors  
Associate Professor Wennan  
Zhang  
Dr Olof Björkqvist

This work is to study co-production of bio-automotive fuels, bio-power, and steam via gasification of the waste biomass streams in the context of the mechanical pulp industry. Ethanol and substitute natural gas (SNG) are chosen to be the bio-transport fuels in the study. The production processes of biomass-to-ethanol, SNG, together with heat and power, are simulated with Aspen Plus. Based on the model, the techno-economic analysis is made to evaluate the profitability of bio-transport fuel production when the process is integrated into a TMP mill. The mathematical modelling starts from biomass gasification. Dual fluidized bed gasifier (DFBG) is chosen for syngas production. From the model, the yield and composition of the syngas and the contents of tar and char can be calculated. The model has been evaluated against the experimental results measured on a 150 KWth Mid Sweden University (MIUN) DFBG. As a reasonable result, the tar content in the

syngas decreases with the gasification temperature and the steam to biomass (S/B) ratio. The biomass moisture content is a key parameter for a DFBG to be operated and maintained at a high gasification temperature. The model suggests that it is difficult to keep the gasification temperature above 850 °C when the biomass moisture content is higher than 15.0 wt.%. Thus, a certain amount of biomass or product gas needs to be added in the combustor to provide sufficient heat for biomass devolatilization and steam reforming. For ethanol production, a stand-alone thermo-chemical process is designed and simulated. The techno-economic assessment is made in terms of ethanol yield, synthesis selectivity, carbon and CO conversion efficiencies, and ethanol production cost.

The calculated results show that major contributions to the production cost are from biomass feedstock and syngas cleaning. A biomass-to-ethanol plant should be built over 200 MW. In TMP mills, wood and biomass residues are commonly utilized for electricity and steam production through an associated CHP plant. Here CHP plant is designed to be replaced by a biomass-integrated gasification combined cycle (BIGCC) plant or a biomass-to-SNG (BtSNG) plant including an associated heat & power centre. Implementing BIGCC/BtSNG in a mechanical pulp production line might improve the profitability of a TMP mill and also help to commercialize the BIGCC/BtSNG technologies by taking into account some key issues such as, biomass availability, heat utilization etc. In this work, the mathematical models of TMP+BIGCC and TMP+BtSNG are respectively built up to study three cases: 1) scaling of the TMP+BtSNG mill (or adding more forest biomass logging residues in the gasifier for TMP+BIGCC); 2) adding the reject fibres in the gasifier; 3) decreasing the TMP SEC by up to 50%. The profitability of the TMP+BtSNG mill is analyzed in comparison with the TMP+BIGCC mill. As a major conclusion, the scale of the TMP+BIGCC/BtSNG mill, the prices of electricity and SNG are three strong factors for the implementation of BIGCC/BtSNG in a TMP mill. A BtSNG plant associated to a TMP mill should be built in a scale above 100 MW in biomass thermal input. Comparing to the case of TMP+BIGCC, the NR and IRR of TMP+BtSNG are much lower. Political instruments to support commercialization of bio-transport fuel are necessary.

*Mid Sweden University Doctoral Thesis, ISSN 1652-893x:188; ISBN 978-91-87557-60-6 (2014)*



## DOCTORAL THESIS

### Selective separation of wood components in internal process waters originating from mechanical pulping

Dissolved and Colloidal substances (DSC) and metals are released from wood during thermomechanical pulp (TMP) production. These components have tendency to accumulate in process waters, as the water circulation systems in integrated paper mills are closed. Disturbances such as pitch depositions in the paper machine (pitch problems), specks in the paper, decreased wet and dry strength, interference with cationic process chemicals, and impaired sheet brightness and friction properties appear when DSC are present. Transition metal ions, such as manganese, result in higher consumption of bleaching chemicals (hydrogen peroxide) and lowers the optical quality of the final product, and addition of complexing agents, such as EDTA or DTPA, to prevent this is needed.

The never ending trends to decrease water consumption and increase process efficiency in pulp and paper production emphasize that it is very important both to know the effects of wood substances of pulping and papermaking and to be able to remove them in an efficient way. From a biorefinery point of view, DSC components can be promising renewable raw materials for biofuels, bio-based chemicals and materials. In this thesis, a new approach using induced air flotation (IAF) without a cationic polyelectrolyte addition for the removal of pitch and metal ions from mechanical pulp mill process waters is presented. The induced air flotation of different processwaters is facilitated by the addition of a chelating surfactant and different foaming agents.

The influence of the pH value, temperature and foaming agent concentration on the flotation efficiency has been investigated. The investigations presented show that the disturbing components can be removed from TMP press



Dr Dariusz Zasadowski

Supervisors  
Professor Magnus Norgren  
Professor Erik Hedenström

water to a high extent. A 90% decrease in turbidity and a 91% removal of lipophilic extractives (i.e. resin and fatty acids, triglycerides, sterols and steryl esters) from unbleached and bleached TMP process water can be obtained by addition of a cationic surfactant as foaming agent during flotation. Lower amount of foaming agent is needed to purify efficiently bleached TMP process water, than unbleached. Additionally, fibres located in TMP press water are not removed with the foam fraction but purified. A retained concentration of hydrophilic extractives (i.e. hemicelluloses and lignans) in the process water indicates that the flotation is selective.

Moreover, by introduction of a new recoverable surface active complexing agent, a chelating surfactant, manganese ions in the form of chelates can be successfully removed from the pulp fibres and separated from the process water in the same flotation process. Furthermore, from the purified unbleached TMP process water a 90% recovery of dissolved hemicelluloses by anti-solvent precipitation was obtained. The findings presented above indicate new possibilities for the internal watercleaning stage to decrease DSC emissions to recipient and for recovery of valuable raw materials from purified process water if flotation technology is applied in an integrated mechanical pulp mill.

*Mid Sweden University Doctoral Thesis ISSN 1652-893x:184; ISBN 978-91-87557-45-3 (2014)*

## DOCTORAL THESIS

### Internal Tar/CH<sub>4</sub> reforming in biomass dual fluidised bed gasifiers towards fuel synthesis

Production of high-quality syngas from biomass gasification in a dual fluidised bed gasifier (DFBG) has made a significant progress in R&D and Technology demonstration. An S&M scale bio-automotive fuel plant close to the feedstock resources is preferable as biomass feedstock is widely sparse and has relatively low density, low heating value and high moisture content. This requires a simple, reliable and cost-effective production of clean and good syngas. Indirect DFBGs, with steam as the gasification agent, produce a syngas of high content H<sub>2</sub> and CO with 12-20 MJ/mn<sup>3</sup> heating value. The Mid Sweden University (MIUN) gasifier, built for research on synthetic fuel production, is a dual fluidised bed gasifier. Reforming of tars and CH<sub>4</sub> (except for methanation application) in the syngas is a major challenge for commercialization of biomass fluidised-bed gasification technology towards automotive fuel production. A good syngas from DFBGs can be obtained by optimised design and operation of the gasifier, by the use of active catalytic bed material and internal reforming.

This thesis presents a series of experimental tests with different operation parameters, reforming of tar and CH<sub>4</sub> with catalytic bed material and reforming of tar and CH<sub>4</sub> with catalytic internal reformer.

The first test was carried out to evaluate the optimal operation and performance of the MIUN gasifier. The test provides basic information for temperature control in the combustor and the gasifier by the bed material circulation rate.

After proven operation and performance of the MIUN gasifier, an experimental study on in-bed material catalytic reforming of tar/CH<sub>4</sub> is performed to evaluate the catalytic effects of the olivine and Fe-impregnated



Dr Kristina Göransson

Supervisor  
Professor Per Engstrand

Ass. Supervisor  
Associate Professor Wennan  
Zhang

olivine (10%wtFe/olivine Catalyst) bed materials, with reference to non-catalytic silica sand operated in the mode of dual fluidised beds (DFB). A comparative experimental test is then carried out with the same operation condition and bed-materials but when the gasifier was operated in the mode of single bubbling fluidised bed (BFB). The behaviour of catalytic and non-catalytic bed materials differ when they are used in the DFB and the BFB. Fe/olivine and olivine in the BFB mode give lower tar and CH<sub>4</sub> content together with higher H<sub>2</sub>+CO concentration, and higher H<sub>2</sub>/CO ratio, compared to DFB mode. It is hard to show a clear advantage of Fe/olivine over olivine regarding tar/CH<sub>4</sub> catalytic reforming.

In order to significantly reduce the tar/CH<sub>4</sub> contents, an internal reformer, referred to as the *FreeRef* reformer, is developed for in-situ catalytic reforming of tar and CH<sub>4</sub> using Ni-catalyst in an environment of good gas-solids contact at high temperature. A study on the internal reformer filled with and without Ni-catalytic pellets was carried out by evaluation of the syngas composition and tar/CH<sub>4</sub> content. It can be concluded that the reformer with Ni-catalytic pellets clearly gives a higher H<sub>2</sub> content together with lower CH<sub>4</sub> and tar contents in the syngas than the reformer without Ni-catalytic pellets. The gravimetric tar content decreases from 25 g/m<sup>3</sup> down to 5 g/m<sup>3</sup> and the CH<sub>4</sub> content from 11% down below 6% in the syngas.

The Mid Sweden University's gasifier has a unique design suitable for in-bed tar/CH<sub>4</sub> catalytic reforming and continuously internal regeneration of the reactive bed material. The novel design of the Mid Sweden University gasifier increases the gasification efficiency, suppresses the tar generation and upgrades the syngas composition.

*Mid Sweden University Doctoral Thesis ISSN 1652-893x:187; ISBN 978-91-87557-58-3 (2014)*

## DOCTORAL THESIS

### Naturally occurring phenols with antioxidant, antifungal and anti-browsing activity

The focus of this thesis is on some phenolic compounds and extracts, which are present in living plants and waste from forest industry. These compounds can be used for numerous applications, and here they were tested for their capacity to prevent oxidation, fungal attack and moose grazing.

Phenols are hydroxylated arenes, commonly occurring in nature. Plants use phenols as inhibitors of tissue degradation caused by radical reactions initiated by oxygen and sunlight. Phenols can also provide protection against fungal attack and browsing animals. Phenols can be extracted from plants and used to make paper, wood and other products more resistant to decomposition. Some phenols also have beneficial health effects for humans as antioxidants and antiinflammatory agents.

Oat (*Avena sativa*) contains two groups of phenols called avenanthramides and avenalamic amides. They protect oat from oxidation, as well as fungal and insect attack.

Thus, they contribute to the long shelf-life of stored oat. In addition, there is evidence that they can protect against certain diseases, such as heart disease, cancer and atherosclerosis. Part of this thesis describes the synthesis of seven avenanthramides which have been found in oats, eight synthetic avenanthramides with similar structure, and two avenalamic amides. These phenols were evaluated for their radical-scavenging activity and antioxidant activity in some common laboratory assays. Several of them were very active, especially those which have hydroxyl and methoxy substituents on the aromatic rings.

There are several methods for extracting phenols from plant material, including solvent extraction. Various factors determine which solvent is most



Dr Amelie Fagerlund Edfeldt

Supervisor  
Professor Erik Hedenström

Ass. Supervisor  
Docent Kerstin Sunnerheim



efficient for extracting substances with a certain activity. Ideally, it should be both cost-efficient and non-toxic. Many plant phenols with antioxidant activity are readily soluble in simple alcohols like ethanol. By heating ethanol or water under pressure and high temperature the extraction becomes very efficient, which enables extraction of large amounts of antioxidants in a short time and with a small amount of solvent. Part of this thesis describes how the extraction temperature and time for pressurized fluid extraction can be optimized to obtain extracts with the highest possible antioxidant activity. The most active extract was obtained by extracting with ethanol at 180 degree C or water at 160 degree C. The extraction time was insignificant within the limits for the experiment and these extracts can be obtained in only five minutes.

Wood-decaying fungi are important decomposers of cellulose and lignin in natural ecosystems. However, when they decompose building material, stored timber and forest plantations these fungi cause problems. Therefore, the wood has to be treated with protecting agents which inhibit the fungal growth. Pulp and paper mills emit large amounts of waste, such as bark and process waters. These waste products contain phenols and other compounds with various interesting bioactivities, such as antioxidant and antifungal activity. Part of this thesis describes that when debarking water, fractions and isolated compounds from it are mixed into the agar solution, the growth of some wood decaying fungi on agar decreases significantly.

Moose browse on tree twigs, preferentially birch and aspen, but also pine. Because pine is a common tree in plantations for the wood industry it is an important feedstock for moose, especially in the winter. When the top shoots are browsed, the pine will not grow straight and will not be suitable as building material. Part of this thesis describes a method to protect the top shoots by spraying them with various plant extracts, that moose dislike. The moose then prefer to browse the side shoots, contribute to regional development, which cause less damage in the growth of the tree.

*Mid Sweden University Doctoral Thesis ISSN 1652-893x:198; ISBN 978-91-87557-77-4 (2014)*

## DOCTORAL THESIS

### **Metal films for printed electronics: ink-substrate interactions and sintering**

A new manufacturing paradigm may lower the cost and environmental impact of existing products, as well as enable completely new products. Large scale, roll-to-roll manufacturing of flexible electronics and other functionality has great potential. However, a commercial breakthrough depends on a lower consumption of materials and energy compared with competing alternatives, and that sufficiently high performance and reliability of the products can be maintained. The substrate constitutes a large part of the product, and therefore its cost and environmental sustainability are important. Electrically conducting thin films are required in many functional devices and applications. In demanding applications, metal films offer the highest conductivity.

In this thesis, paper substrates of various types, and construction were characterized, and the characteristics were related to the performance of inkjet-printed metal patterns. Fast absorption of the ink carrier was beneficial for well-defined pattern geometry, as well as high conductivity. Surface roughness with topography variations of sufficiently large amplitude and frequency was detrimental to the pattern definition and conductivity. Porosity was another important factor, where the characteristic pore size was much more important than the total pore volume. Apparent surface energy was important for non-absorbing substrates, but of limited importance for coatings with a high absorption rate. Applying thin polymer-based coatings on flexible non-porous films to provide a mechanism for ink solvent removal, improved the pattern definition significantly. Inkjet-printing of a ZnO-dispersion on uncoated paper provided a thin spot-coating, allowing conductivity of silver nanoparticle films. Conductive nanoparticle films could not form directly on the uncoated paper.



**Dr Thomas Öhlund**

Supervisor  
Professor Håkan Olin

Ass. Supervisor  
Professor Hans-Erik Nilsson  
Researcher Mattias Andersson

The resulting performance of printed metal patterns was highly dependent on a well adapted sintering methodology. Several sintering methods were examined in this thesis, including conventional oven sintering, electrical sintering, microwave sintering, chemical sintering and intense pulsed light sintering. Specially designed coated papers with modified chemical and physical properties were utilized for chemical low-temperature sintering of silver nanoparticle inks. For intense pulsed light sintering and material conversion of patterns, custom equipment was designed and built. Using the equipment, inkjet-printed copper oxide patterns were processed into highly conducting copper patterns. Custom-designed papers with mesoporous coatings and porous precoatings improved the reliability and performance of the reduction and sintering process.

The thesis aims to clarify how ink-substrate interactions and sintering methodology affect the performance and reliability of inkjet-printed nanoparticle patterns on flexible substrates. This improves the selection, adaptation, design and manufacturing of suitable substrates for inkjet-printed high conductivity patterns, such as circuit boards or RFID antennas.

*Mid Sweden University Doctoral Thesis ISSN 1652-893x:210; ISBN 978-91-87557-98-9 (2014)*

## DOCTORAL THESIS

### **Development of catalytic enantioselective C-C bond-forming and cascade transformation by merging homogeneous or heterogeneous transition metal catalysis with asymmetric aminocatalysis**

Chiral molecules play a central role in our daily life and in nature, for instance the different enantiomers or diastereomers of a chiral molecule may show completely different biological activity. For this reason, it is a vital goal for synthetic chemists to design selective and efficient methodologies that allow the synthesis of the desired enantiomer. In this context, it is highly important that the concept of green chemistry is considered while designing new approaches that will possibly provide a more environmental and sustainable chemical synthesis.



The aim of this thesis is to develop the concept of combining transition metal catalysis and aminocatalysis in one process (dual catalysis). This strategy would give access to powerful tools to promote reactions that were not successful with either transition metal catalyst or the organocatalyst alone.

<b>Dr Samson Afewerki</b>
Supervisor Professor Armando Córdova
Ass. Supervisor Docent Ismail Ibrahim


The protocols presented in this thesis based on organocatalytic transformations via enamine or iminium intermediates or both, in combination with transition metal catalysis, describes new enantioselective organocatalytic procedures that afford valuable compounds with high chemo- and enantioselectivity from inexpensive commercial available starting materials. In paper I, we present a successful example of dual catalysis: the combination of transition metal activation of an electrophile and aminocatalyst activation of a nucleophile via enamine intermediate. In paper II, the opposite scenario is presented; here, the transition metal activates the nucleophile and the aminocatalyst activates the electrophile via an iminium intermediate.

In paper III, we present a domino Michael/carbocyclisation reaction that is catalysed by a chiral amine (via iminium/enamine activation) in combination with a transition metal catalysts activation of an electrophile. In paper IV, the concept of dual catalysis was further extended and applied for the highly enantioselective synthesis of valuable structural scaffolds, namely poly-substituted spirocyclic oxindoles.

Finally, in paper V, the concept of dual catalysis was expanded, by investigating more challenging and environmentally benign processes, such as the successful combination of a heterogeneous palladium and amine catalysts for the highly enantioselective synthesis of functionalised cyclopentenes, containing an all carbonquaternary stereocenter, dihydrofurans and dihydropyrrolidines.

*Mid Sweden University Doctoral Thesis ISSN 1652-893x:206; ISBN 978-91-87557-90-3 (2014)*





*More than 70 researchers work at the research centre FSCN. On the following pages you will meet a selection of the researchers and their own presentations of their research in 2014.*

## 10. A SELECTION OF RESEARCHERS WITHIN FSCN 2014

### The bio-based economy as driver of innovation and research

In the recent years, I have focused on the potential renewal of the forest industry in the future bio-based economy. Thereby I work with national strategies and take initiatives for new cross-boundary cooperation. I am especially interested in developing regional and national competitiveness through knowledge-based innovations with high added value, and I like to use societal challenges and customer need as driving forces.



Two years ago, I lead the work with a strategic research and innovation agenda for the joint paper and textile industries in Sweden, reported in “Made in Sweden – Future Textiles and Printing”. I have then worked actively with integrating this with similar efforts, and this was recently greatly rewarded when BioInnovation was granted by Vinnova, Formas and Energimyndigheten. BioInnovation is a 600 MSEK 6 year program years with a vision that Sweden will be a bio-based economy in the middle of this century. I have a central position in BioInnovation as chair of Expert Team Materials and member of the Advisory Board, but also as a strategist in the program management team.

Per Edström
Professor of Applied Scientific Computing
BioInnovation

I am a member of the faculty board and in the steering group of FSCN. I am also the subject leader of mathematics at Mid Sweden University, and thereby lead the strategic development of mathematics in education, post graduate studies and research. Mathematics has around 25 coworkers at Mid Sweden University, including 4 professors.



During 2014, I was supervisor for 3 PhD students, resulting in one licentiate degree and a number of publications.

## Processes in mechanical pulping

The main activities in 2014 have been as assistant supervisor to the PhD students Sofia Enberg (FSCN), Erik Nelsson (FSCN), and Pia Hellström (KaU), lecturer of the courses Unit Processes in Mechanical Pulping (FSCN) and Cellulose Technology (CTH), and participation in the Science and Innovation Day.

The research work has resulted in the following publications:

- Walter K.; Paulsson M.; Engstrand P. *Acid hydrogen peroxide treatment of Norway spruce TMP: The effect of an extended pH range when catalyzed by free ferrous and free or EDG/EDTA-chelated ferric ions*. J. Wood Chem. Technol. 34:1-2, 135, 2014.
- Walter K.; Paulsson M.; Engstrand P. *Acid hydrogen peroxide treatment of Norway spruce TMP: The effect of chelated ferric ions*. 28th Int. Mech. Pulp. Conf., Helsinki, Finland, June 2-5, Fiber treatment section, 4 pp, 2014.
- Karlsson A.; Paulsson M.; Engstrand P.; Hedenström E. *Strategies to reduce heat-induced darkening for enhanced bleachability of mechanical pulps*. Appita 67:1, 50, 2014.
- Enberg S.; Rundlöf M.; Paulsson M.; Axelsson P.; Eriksen Ø.; Engstrand P. *The influence of process waters on optical properties during storage of hydrogen-peroxide bleached Norway spruce mechanical pulp*. Nord. Pulp Pap. Res. J. 29:2, 344, 2014.
- Enberg S.; Rundlöf M.; Paulsson M.; Axelsson P.; Eriksen Ø.; Engstrand P. *Some causes of formation of colour during storage of hydrogen-peroxide bleached Norway spruce mechanical pulp*. Nord. Pulp Pap. Res. J. 29:2, 356, 2014.
- Hellström P.; Heijnesson-Hultén A.; Paulsson M.; Håkansson H.; Germgård U. *The effect of Fenton chemistry on the properties of microfibrillated cellulose*. Cellulose 21:3, 1489, 2014.
- Hellström P.; Heijnesson-Hultén A.; Paulsson M.; Håkansson H.; Germgård U. *Fenton pre-treated microfibrillated cellulose evaluated as a strength enhancer in the middle ply of paperboard*. Nord. Pulp Pap. Res. J. 29:4, 732, 2014.



Magnus Paulsson

Adjunct Professor of Mechanical Fibre Technology (sponsored by AkzoNobel)

High Yield Pulping Technology

- Hellström P.; Heijnesson-Hultén A.; Paulsson M.; Håkansson H.; Germgård U. *The effect of Fenton chemistry on the properties of microfibrillated cellulose – Characterization and paper board application*. 5th Nord. Wood Bioref. Conf., Stockholm, Sweden, March 25-27, 269, 2014.
- Salmén L.; Viforr S.; Mårtensson T.; Sixta H.; Ylönen T.; Fernando D.; Daniel G.; Sandström P.; Moberg A.; Paulsson M.; Bäck R. *Enzymatic chip treatment for TMP – Prospects*. 28th Int. Mech. Pulp. Conf., Helsinki, Finland, June 2-5, 4 pp, 2014.

## New technologies in the TMP and CTMP Industry

Nowadays, I am working part-time as senior professor mainly in projects managed by three of my former PhD students. We are focusing on developing new technologies, which can be used in the TMP and CTMP industry, within three different fields;

- Reduction of electric energy consumption in refining (managed by Birgitta Engberg)
- Improvements of out-of-plane strength in bulky sheet structures (managed by Gunilla Pettersson)
- Improvements of in-plane strength and stiffness in sheets intended to be used in products with very high demands on strength, e.g. packaging paper and liner-board, (managed by Sven Norgren)



Hans Höglund

Professor of Mechanical Pulping Technology

High Yield pulping Technology

The projects are mostly carried out in pilot plant scale in cooperation with industrial partners. To achieve a reduction of energy consumption, we are studying effects of non-conventional refiner plate patterns, where fibres can be treated energy efficiently in a wide range of plate gaps. Improvements of out-of-plane strength, without significant reduction of sheet bulk, are effected by addition of polymers (mostly cationic starch and CMC) according to a so-called MIX-technology. With that technology, the out-of-plane strength can be more than doubled at a maintained high bulk within the bulk range of interest for middle plies in carton-boards (see Pettersson, G. et al in Proceedings from IMPC 2014). To get very significant improvement of in-plane strength, we are looking at the combined effects of energy efficient refining at temperatures well above the softening temperature of lignin, fibre surface modifications and sheet pressing technologies at higher than conventional dry contents and temperatures (see Norgren, S. et al in Proceedings from IMPC 2014).

In all the three project we are now in a phase where the possibilities of implementation in mill applications are discussed with industrial partners.



## Chemical ecology

My focus is chemical ecology and more specifically identification and synthesis of natural compounds utilized in insect communication. I have worked on several projects concerning different insects species, such as orchid bees, butterflies, thrips, bed bugs and fruit flies and more recently I have been working on projects based on insects, such as wax moth and bark beetles.

During 2014, I published two papers, the first paper concerned the identification and synthesis of a compound found in Australian thrips. The new invention in this paper is the identification of the active Z isomer of 3-dodecenoic acid which was identified for the first time in this insect species. The second paper is about the synthesis and analytical identification of the 8 isomers of 6,10,14-trimethylpentadecan-2-ol a substance found in several insect species. The new invention in this paper is a new asymmetric synthesis and the gas chromatographic separation of the eight alcohol isomers after derivatization.

In September, I defended my thesis titled "The Scents of Nature Identification and Synthesis of Bioactive Molecules". In December, I got accepted to the "Meriteringsprogram" at Mid Sweden University and I will continue to perform research within this program in chemical ecology.



Erika A. Wallin

Dr., Research Assistant

Eco Chemistry

## Low consistency refining of mechanical pulp in the light of forces on fibres

I was the main author of the paper “Low-consistency refining of mechanical pulp in the light of forces on fibres”, which was accepted in 2014 for publication in Nordic Pulp and Paper Research Journal. The aim of that investigation was to find new approaches to evaluate the performance of low-consistency refiners. Data from a paper mill producing TMP from Norway spruce was used in order to find a possible way to calculate the power split between the zones in a TwinFlo refiner. An assumption of equal amount of fibres captured between overlapping bars was found successful in order to develop equations for the power split. The equations predicted equal power in both zones at equal disc gaps. The power was found to increase approximately linearly with decreasing disc gap over the range, 0.1-0.2 mm. The power split was essential to know for calculating refining intensities expressed as specific edge load and forces on fibres in the two zones. The reduction in fibre length was about 5% at 0.17 mm disc gap or at 0.03 N forces on fibres or at 0.7 J/m specific edge load. The disc gap, forces on fibres and specific edge load were found to predict fibre shortening approximately equally upon changes in power and flow rate through the refiner.



Jan-Erik Berg

Dr., Research Engineer

High Yield Pulping Technology

### Papers accepted for publication during 2014

- Berg, J.-E., Sandberg, C., Engberg, B. E., and Engstrand, P. *Low-consistency refining of mechanical pulp in the light of forces on fibres*. Nordic Pulp Paper Res. J. 30(2), 225-229.
- Sandberg, C., and Berg, J.-E. *Effect of flow recirculation on pulp quality and energy efficiency in low consistency refining of mechanical pulp*. Nordic Pulp Paper Res. J. 30(2), 230-233.
- Gradin, P. A., Berg, J.-E., and Nyström, S. K. *Measuring Tangential Forces in a Pulp Refiner: A Novel Approach*. Exp. Tech. doi: 10.1111/ext.12120

## Morphology studies on future biocomposite

We are using renewable and environmentally friendly materials to develop advanced fiber-based products with electronic functionality, such as supercapacitors for energy storage and solar cells.

In supercapacitors, the electrodes can be made of graphene or nanographite. By mixing this material with cellulose nanofibrils (CNF) we found that the coating dispersion became stabilized and also the runnability was improved. CNF has also proved to be useful as a binder in the electrode. Both the wet and dry strength was improved while the electronic properties were retained or even improved.

In my research, the morphology is examined to understand how the CNF and the graphene/nanographite build up the structure of this strong and functional biocomposite.

- Andres, B., Forsberg, S., Dahlström, C., Blomquist, N., and Olin, H., *Physica Status Solidi B*, 2014.
- Dahlström, C., Andres, B., and Forsberg, S., *TAPPI Advanced Coating Fundamentals Symposium*, Minneapolis, 2014.

During 2014, I was Vice-Chair of the Program Committee TAPPI Advanced Coating Fundamentals Symposium. At the ACFS 2014, I had a presentation and I was also a session chair.

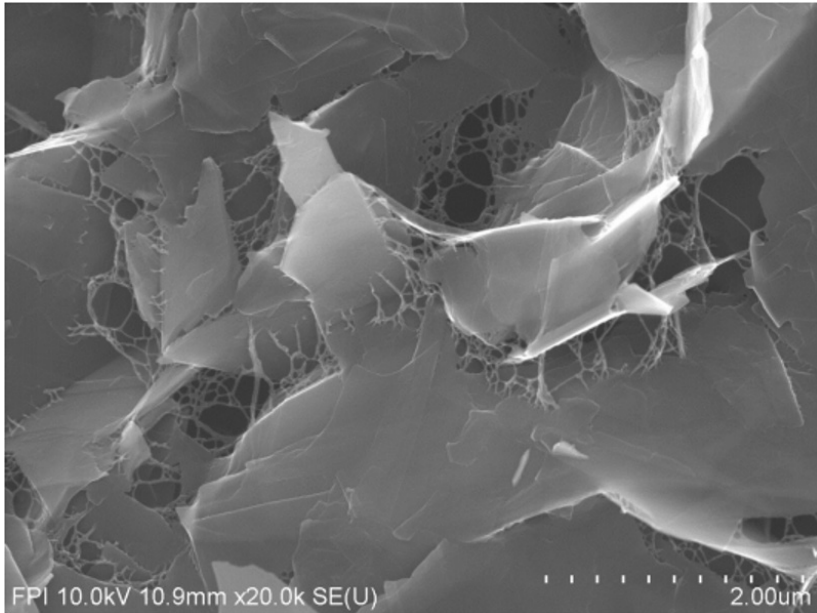
I was awarded with the Alf de Ruvo scholarship of 2014. This scholarship gave me the opportunity to work as a visiting scholar at Stanford University, USA (6 months 2014-2015).



Christina Dahlström

Dr., Researcher

Complex Materials



*Figure 1. Scanning electron microscopy image of the electrode surface. Fibrillated nanocellulose is creating a spider web formation between the graphite particles.*

## Paper-based Supercapacitors

During 2014, I conducted research within the KEPS (Kinetic Energy Storage in Paper-Based Supercapacitors) project. One of my research interests within this project was the development of electrodes for supercapacitors. I prepared nanographite-nanocellulose composites and tested their performance as electrodes in supercapacitors. My results showed that nanofibrillated cellulose can be used as a binder in graphite electrodes without degrading the electrical properties of the electrodes. Adding small amounts of nanofibrillated cellulose even increases the capacitance of the supercapacitors. Based on these results, I published the article "Enhanced electrical and mechanical properties of nanographite electrodes for supercapacitors by addition of nanofibrillated cellulose" in *Physica Status Solidi B*.



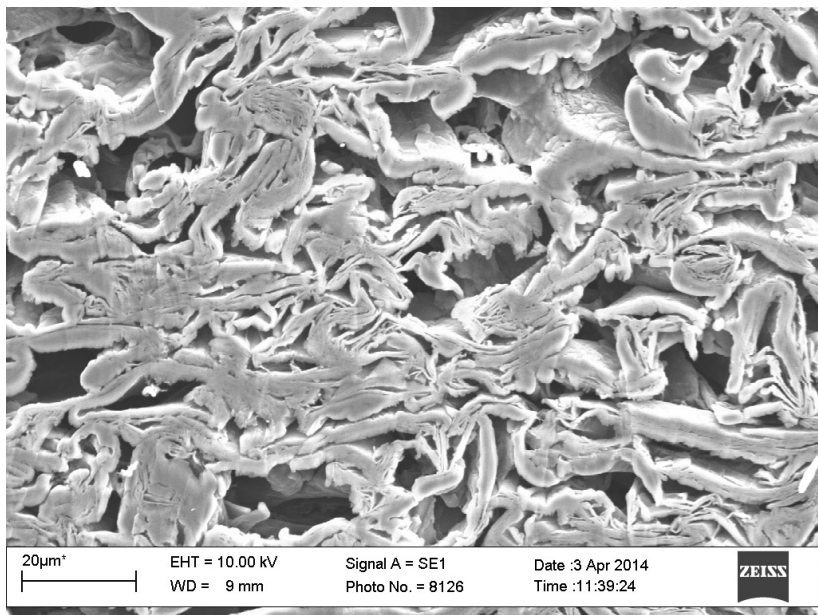
<b>Britta Andres</b>
PhD Student
Materials Physics

In February, March and June, I attended two international winter schools and one conference on graphene and related 2D materials. At these three occasions, I presented my work on graphite electrodes for supercapacitors, nanographite-nanocellulose composites and the production of graphene by mechanical exfoliation in a homogenizer.

In June 2014, I presented my Licentiate thesis with the title "Paper-based Supercapacitors" (ISSN 1652-8948:112; ISBN 978-91-87557-68-2)

In the second half of the year, I focused on the influence of the electrode mass ratio on the capacitance of supercapacitors. With the help of a series of experiments, I could demonstrate that one can increase the capacitance by adjusting the electrode mass ratio to the ion size ratio. An article discussing these results will be published in 2015.





*Figure 1: The image shows the cross section of a graphite-nanocellulose electrode.*

## Mechanical Pulp Based Nano-ligno-cellulose

I'm a graduate student at Mid Sweden University, working at the Fibre Science and Communication Network (FSCN) Centre, in the research group High Yield Pulping Technology. My educational background is as follows:

- 2014- Present: PhD student (Chemical Engineering), Mid Sweden University, Sundsvall.
- 2011-2014: Lic (Chemical Engineering), Mid Sweden University, Sundsvall
- 2009-2011: M.Sc. (Chemical Engineering), Mid Sweden University, Sundsvall
- 2008-2009: M.Sc. Course work (Chemical Engineering), Malärdalen University Eskilstuna
- 2003-2006: B.Sc. (Chemistry), University of Buea, Cameroon.



Sinke Henshaw Osong

PhD Student

High Yield Pulping Technology

The principal axes of my research include:

- Development of cellulosic nanofibres from high yield pulps (CTMP & TMP) and chemical pulps (Sulphate and Sulphite Pulp)
- Biorefinery for the mechanical pulping industry in order to produce nanofibres for value-added products in packaging sector
- Chemical modification of wood-based fibres. Chemical pretreatment of pulp fibres by using the chemistry of the hydroxyl groups of pulp fibres (cellulose)
- Processing and characterisation of nano-ligno-cellulose from mechanical pulps
- Papermaking and characterisation
- Scientific communication (scientific writing, oral and poster presentations)
- Last but not the least, I wish to learn more about the manufacturing of nanocomposites based on cellulosic nanomaterials and other engineering polymer matrices

The SEM picture in Figure 1 shows the morphological surface structure of pure CTMP-based NFC.

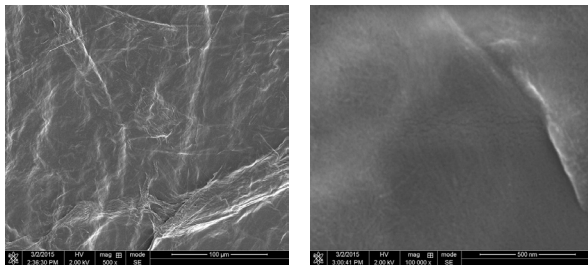


Figure 1. SEM surface images of pure CTMP-based NFC films (where the left and right column show the sample images taken at magnification 500x and 100,000x).

### Award

Best IMPC 2014 oral presentation by young researcher - ERGS Keith Kirkpatrick Award 2014 at the International Mechanical Pulping Conference, 2-5 June, Helsinki, Finland

### Conferences

- 25/11/2014 - 27/11/2014: EFPRO-CEPI Seminar "New ideas for the paper industry - Young researcher's presentation" in the Frame of the CEPI European Paper Week 2014, Brussels, Belgium
- 23/06/2014 - 26/06/2014: 2014 Tappi International Conference on Nanotechnology for Renewable Materials, Vancouver, Canada
- 27/08/2014 - 29/09/2014: Cellulose Materials Doctoral Students Summer Conference 2014, Germany
- 31/05/2014 - 01/06/2014: ERGS Technical Meeting, Finland
- 02/06/2014 - 05/06/2014: International Mechanical Pulping Conference (IMPC) 2014, Helsinki, Finland

### Publications

- Osong, S. H., Norgren, S. & Engstrand, P. (2014). *Paper strength improvement by inclusion of nano-ligno-cellulose to Chemithermomechanical pulp*. Nordic Pulp & Paper Research Journal, vol. 29: 2, pp. 309-316.
- Osong, S. H., Norgren, S., Engstrand, P., Lundberg, M. & Hansen, P. (2014). *Crill: A novel technique to characterize nano-ligno-cellulose*. Nordic Pulp & Paper Research Journal, vol. 29: 2, pp. 190-194.
- Osong, S. H., Norgren, S., Engstrand, P., Lundberg, M. & Hansen, P. (2014). *Development of nano-ligno-cellulose produced from mechanical pulp*. In International Mechanical Pulping Conference, IMPC 2014.
- Osong, S. H. (2014). *Mechanical Pulp Based Nano-ligno-cellulose: Production, Characterisation and their Effect on Paper Properties*, 2014 Mid Sweden University licentiate thesis: ISSN 1652-8948:109; ISBN 978-91-87557-42-2

## Chip pre-treatment combined with high intensity DD-refining

During 2014, I have been continuing the work with my PhD project. The goal of the project is to examine if the electric energy consumption in a modern TMP process can be reduced by 15% by means of combining wood chips pretreatment with increased refining intensity. The fundamental hypothesis behind this project is that softening of wood makes it possible to treat wood fibers in a more efficient way using increased refining intensity without negative influence on fiber properties. The hypothesis was tested by combining mechanical chip-pretreatment and wood chips softening with high intensity refining. This was accomplished by means of using lignin sulfonation and increased refining intensity achieved by means of changed refiner segment design and increased production rate. To demonstrate this, five full-scale experiments were conducted at Braviken papermill (Holmen Paper AB). The results shows that when the chips were pretreated with 3.6 kg sodium sulfite per ton and refined with a high intensity segment design at increased production rate, the electric energy consumption was reduced by 15%. The reference pulp was produced by using standard segments without either chip pretreatment or sulfite impregnation. Comparisons were made to the same tensile strength and light scattering coefficient. It should be emphasized that the combination of wood softening and new segment design also makes it possible to increase the production rate by ~ 25%.



Erik Nelsson
PhD Student Holmen Paper AB
High Yield Pulping Technology

### Publications in 2014

- Nelsson, E., Sandberg, C., Svensson-Rundlöf, E., Muhic, D., Rohden, L., Engberg, B.A., Engstrand, P. (2014): *Improved energy efficiency in thermomechanical pulping through co-optimization of intensity by segment design and wood softening by sulfonation*, In Proceedings of International Mechanical Pulping Conference, Helsinki, Finland.

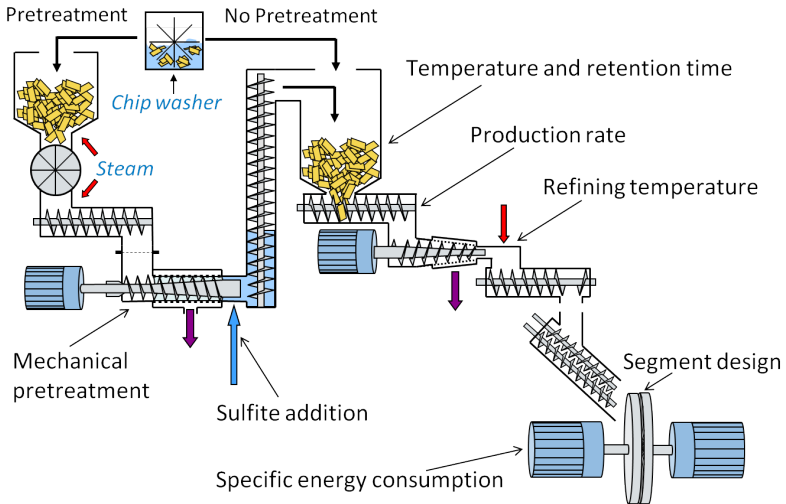


Figure 1. A schematic description of the process used for the trials in this study. It is possible to bypass the mechanical pre-treatment by sending chips from the chip washer directly to the pre-heater bin. The different process parameters that were studied are shown together with an arrow marking the locations of the parameters in the process.

## Improved energy efficiency in refining

In general, I am very much interested in understanding the wood matrix and the wood polymers better than we do today. Wood is a viscoelastic-plastic, unisotropic material that can be softened by thermal, mechanical and chemical pre-treatments prior to refining, however, the effects of the pre-treatments depend very much on the refining process conditions. So, to evaluate different pre-treatment techniques in lab-scale, the wood material needs to be tested under relevant conditions which in this case means at high temperatures, in a steam environment and at high strain rates. New and unconventional testing techniques are therefore needed which implies challenges.

During 2014, I have been involved in several research projects in the area of high yield pulping technology. The projects have mainly focused on improving refining energy efficiency by utilizing pre-treatments, altered refining intensity (or harshness) and/or non-conventional refiner plate patterns.

The projects were carried out in lab scale, pilot plant scale and in mill scale in cooperation with industrial partners. During the year I have also been on parental leave for 7 months.

### Publications in 2014

- Engberg, B.A., Logenius, L. and Engstrand, P.O. (2014): *Mechanical properties of sulfonated wood in relation to wing refiner pulp properties*, in Proceedings of International Mechanical Pulping Conference, Helsinki, Finland
- Nelsson, E., Sandberg, C., Svensson-Rundlöf, E., Muhic, D., Rohden, L., Engberg, B.A., Engstrand, P. (2014): *Improved energy efficiency in thermomechanical pulping through co-optimization of intensity by segment design and wood softening by sulfonation*, In Proceedings of International Mechanical Pulping Conference, Helsinki, Finland



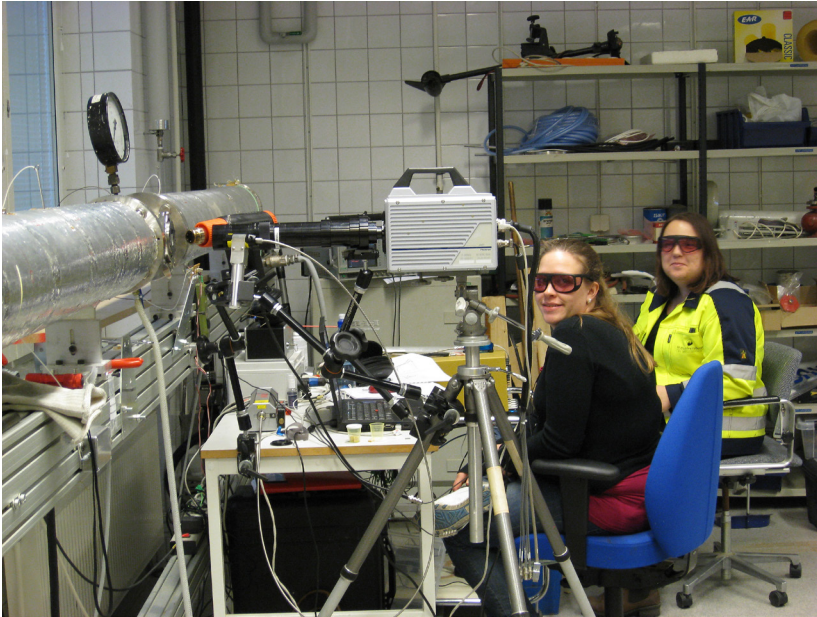
Birgitta Engberg

Dr., Researcher

High Yield Pulping Technology



- Moilanen, C., Engberg, B.A., Björkqvist, T., Salminen, L. and Saarenrinne, P. (2014): *Local compression behaviour of pre-fatigued and chemically pre-treated wood at high strain rate and high temperature*. In Proceedings of International Mechanical Pulping Conference, Helsinki, Finland
- Berg, J-E., Sandberg, C., Engberg, B.A. and Engstrand, P. (2014): *LC Refining Intensity In The Light Of Forces On Fibres*, In Proceedings of International Mechanical Pulping Conference, Helsinki, Finland.



*Photo from lab-scale trials where we used the Split-Hopkinson testing technique to study high strain-rate compression of pre-treated wood in a hot steam atmosphere. To study local compression behavior, we also used a high speed camera and a special laser lightening technique to capture as many image frames as possible during the impulse loading. A cooperation with Tampere University of Technology in Finland.*

## Mechanical properties of densified cellulose materials

Plastic bags and packages last for a long time but are often used for a short time. They are mainly made of fossil based resources. The plastic world we live in is not sustainable even though some of the plastics are recycled and a small fraction of it is bio-based. Replacing plastic materials with those made from renewable resources will make the world greener and more sustainable. Cellulose is an abundant organic material available in large volumes and therefore, attempting to use for replacing plastics in some applications. In order to extend the property range of cellulose materials, the material needs to be more homogenous and densified in order to be more plastic look-alike. Densified cellulose materials might also be used as a matrix for composites reinforced with glass or carbon fibers especially under dry conditions. My interests are to measure strengths of those densified cellulose materials at various length scales both in the plane but also out of plane and in shear. These measurements might guide the development of densified paper materials towards improved material properties.



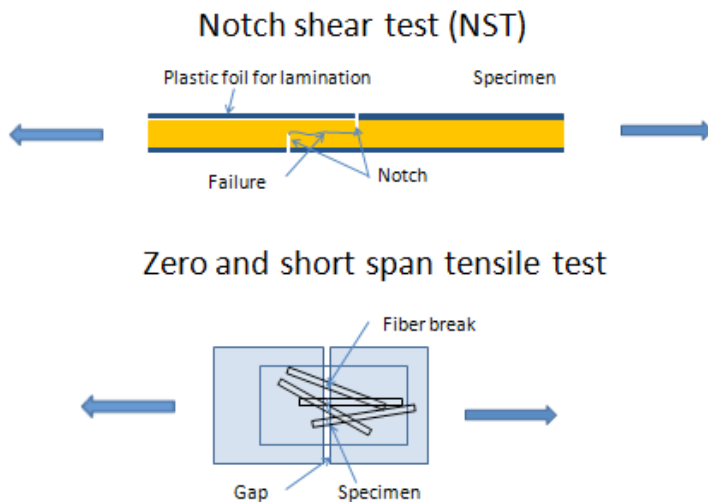
Bo Westerlind

Guest Professor of Paper Physics

Complex Materials

An increased density can be obtained by mechanical and chemical treatment of the fibers combined with high pressing before or during drying. Many of those treatments have negative effects on load bearing elements in cellulose like fiber length, fibril aggregate length, fibril length and the length of the cellulose molecule. In order to have a strong and ductile cellulosic material it is important that the aspect ratio or the length to width ratio is high for all of those. There are many devices that can be used to analyze the size and characteristics of the structural components in paper at various length scales. Many of these measuring techniques are time consuming but from a scientific point of view preferable to use. Two fast measuring techniques with some built in problems due to the boundary conditions are tensile tests at zero or short spans and shear notch test. The fast test response has attracted my interest because that makes them suitable for screening tests in material development. The zero span tensile test provides information on fiber stress-strain

response while the shear notch test provides information about fiber-to-fiber bond strength.



*Figure 1. Schematics of notch shear test above and zero and short span tensile test below.*

## **LiON / Cost effective silicon-carbon composite anodes for lithium-ion batteries in automotive application**

It is becoming obvious to everyone that the massive use of fossil fuels in the world must be phased out. The transport sector is a large consumer of petroleum-based fuels. The batteries are at the moment the crucial limiting factor preventing large-scale electrification of the vehicle fleet. A significant increase in the current battery capacity is needed before electric cars can be competitive to diesel- or gasoline-driven cars. Among the available battery technologies, the lithium-ion battery is at present the most used concept.



Joakim Bäckström

Associate Professor

Materials Physics

In the simplest possible explanation model, a battery consists of three key components: an anode, a cathode and an electrolyte separating the two. All three components are subject to intense scientific work. In a project starting in the beginning of 2015 that has been granted funding during 2014 we will look closer into the anode at the Mid Sweden University with the objective of increasing the charging capacity while keeping costs low. We will investigate a new, cost-efficient and scalable way to make silicon-carbon composites and use it as anode material. We have for a number of years worked on carbon-based supercapacitors for recovery of braking energy in vehicles. We also have a track record in research on materials in general and for electrochemical applications in particular. The research on vehicle batteries thus fits very well in the project portfolio. The project is a close collaboration with the companies Vesta Si Europe and Superior Graphite and the academic partner KTH.

The Swedish Energy Agency, Vesta Si Europe, and Superior Graphite finance this project.

## **Högox / Highly selective electrocatalysts for anodic oxidation**

In an electrochemistry project managed from KTH, Mid Sweden University plays an important role. Highly oxidising compounds like ozone and perchlorates are important chemicals for a variety of processes, including water

treatment and sterilization. A very convenient way of producing them is through electrolysis of water solutions. However, electrochemical production of highly oxidative species tends to show low efficiency since side reactions like oxygen evolution is often favoured.

What reactions are favoured is to a large extent determined by the electrode material. A material that allows for an efficient production of the desired product with a low energy demand is said to have high selectivity towards that particular reaction. Recently, it was shown that tin oxide doped with antimony and nickel has a record high selectivity towards ozone evolution from water.

In this project, we combine advanced materials preparation with state-of-the-art electrochemical investigations and solid-state physics to investigate the reason behind the high ozone selectivity of tin oxides. If we can find an explanation for the performance, we can optimize the functionality and perhaps also learn how to suppress undesired oxygen evolution also in other electrochemical processes.

The project is financed by Formas.

## Wood processing

The activities during the last two years have mainly been directed towards theoretical and experimental studies of wood - cutting and mechanical refining.

In *“A Numerical and Experimental Study Regarding the Influence of Some Different Process Parameters on the Damage State in Wood Chips.* Isaksson P., Gradin P. A., Hellström L. M. *Holzforschung*, DOI: 10.1515/hf-2012-0142, (2013)” an attempt to optimize the damage induced to a wood chip is made and an optimal knife edge angle is determined.



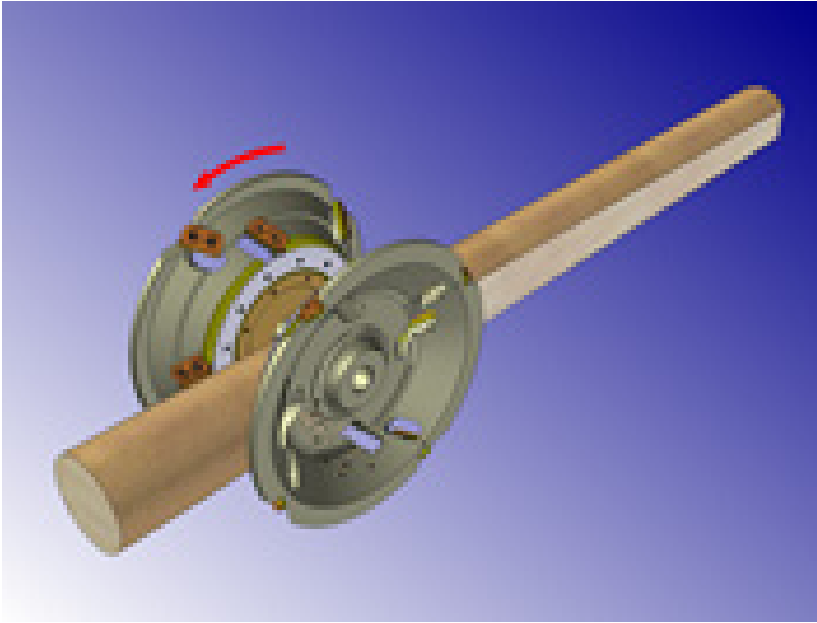
A method used in the sawmill industry to reduce the circular cross section of a log to a quadratic one, is chipper canting. A chipper canter is in essence a conical disk equipped with knives and a circular saw blade as shown in figure 1.

Per Gradin
Professor of Solid Mechanics
High Yield Pulping Technology

In *“A Theoretical Model for the Prediction of Energy Consumption During the Chipper Canter Process.* Lusth H., Gradin P. A., Hellström L. M. *Nordic Pulp and Paper Research Journal*, Vol 28, no. 2, June 2013.” and in *“A Theoretical and Experimental Study of the Circular Sawing Process.* Hellström L. M., Biller S-O, Edvardsson S, Gradin P. A. *Holzforschung*, DOI: 10.1515/hf-2013-0066, (2013)” the two sub processes involved in chipper canting are analysed.

In the mechanical refining process, it is of interest to know how the power input to the refiner is distributed over the refiner plates. To that end, one would like to measure the tangential forces in the refiner gap. A variety of sensors has been proposed over the years. In *“Measuring Tangential Forces in a Pulp Refiner: A Novel Approach.* Gradin P. A., Berg J. E., Nyström S. *Experimental Techniques*. DOI: 10.1111/ext.12120, (2014)” a completely new approach is taken, which make the sensor well suited for the harsh environment in a refiner gap.

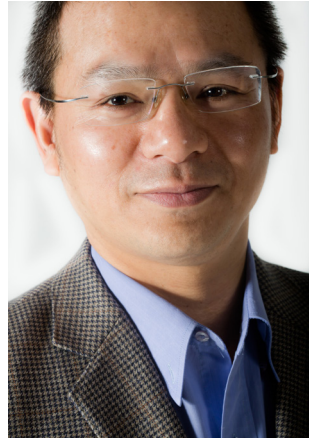




*Fig. 1 Chipper canting*

## Bioenergy

I am the leader of the Bioenergy research group at FSCN. The group research is directed to the thermo-chemical conversion of biomass into syngas for the downstream production of electricity, automotive fuels and chemicals, such as DME, FT fuels, methanol, ethanol, synthetic natural gas (SNG), hydrogen etc. It is, so-called BTL (biomass to liquids).



Wennen Zhang

Associate Professor

Bioenergy

In the current work, the objectives are:

1. to develop a pilot-scale dual fluidized bed gasifier (DFBG) for production of a high quality syngas.
2. to simulate the biorefinery concept when the gasifier is integrated in a mechanical pulp fibre line.

The research emphasis is on developing and improving the gasification technology by the use of catalytic bed material and internal reformer in the Mid Sweden University's DFBG and simulation of biomass-to-ethanol/Bio-SNG in the context of a mechanical pulp mill. The current projects are:

- **Bio2Fuels 2030**, pre-study, funding from EU regional development funds
- **Miljöhorisont 2020** – waste to vehicle fuels, pre-study, funding from EU regional development funds
- **Fuel Flexibility**, Funding from LKAB
- **Swedish Gasification Centre**, as a member in the centre, funding from Energimyndigheten

The Mid Sweden University's DFBG is a 150 kW indirect biomass gasifier as shown here, which was developed by the Bioenergy research group.

The research work has resulted in the following publications, PhD exams and patent:

- Göransson, K.; *"Internal tar/CH<sub>4</sub> reforming in biomass dual fluidized bed gasifiers towards fuel synthesis"*, Doctoral Thesis, 187, Mid Sweden University (2014)

- He, J.; *"Gasification-based biorefinery for mechanical pulp mills"* Doctoral Thesis, 188, Mid Sweden University (2014)
- Söderlind, U., Zhang, W., Göransson, K. and Engstrand P.; *"A fluidized bed gasifier system"* Patent application: EP 14 163 446.9, (2014, Europe)
- Jiang X., Song X., Chen Y. & Zhang W., *"Research on biogas production potential of aquatic plants"*, Renewable Energy, 69, p. 97-102, (2014)
- He, J., Engstrand, P. and Zhang, W., *"Bio-SNG production in a TMP mill in comparison with BIGCC"*, Energy Procedia 61, 2894-2897, (2014)
- Göransson K., Söderlind U., Henschel T., Engstrand P. & Zhang W., *"Internal tar/CH<sub>4</sub> reforming in a biomass dual fluidised bed gasifier"*, Biomass Conversion and Biorefinery, doi:10.1007/s13399-014-0151-5, (2014)
- Göransson K., Söderlind U., Engstrand P. & Zhang W., *"An experimental study on catalytic bed materials in a biomass dual fluidised bed gasifier"*, Renewable Energy 81, 251-261, (2015)

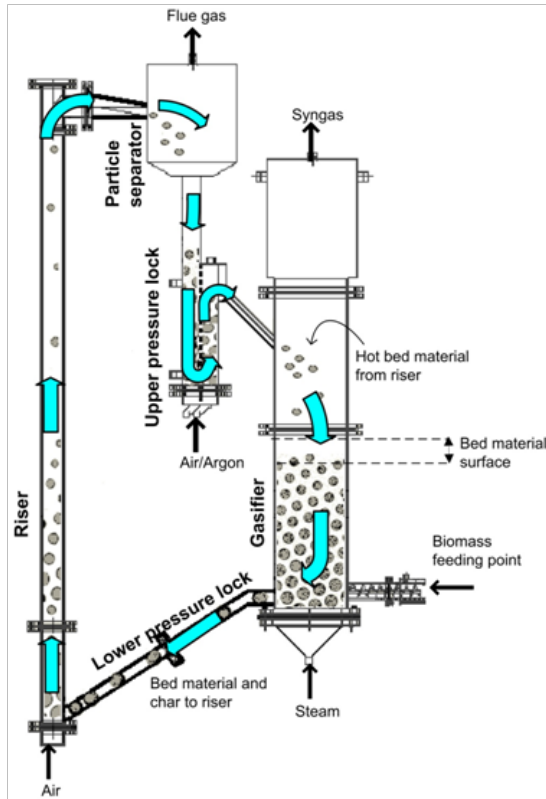


Figure 1. The Mid Sweden University's dual fluidized bed gasifier (DFBG).

## New ways to use paper

My primary duties concern research administration as a Research Director for FSCN. Aside from that, I am helping to develop research projects and development cases that specifically focus on paper as a raw material rather than and product. The research projects whose development I am involved in focus on paper textiles or paper yarns, and the development cases on something that we call 3D design of sandwich structures. The latter are part of the BioBusiness Arena of Åkroken Science Park.



Kaarlo Niskanen

Professor of Chemical Engineering  
and Research Director

FSCN

Naturally, I have lots of fun with the above, but there are also a number of reasons why I feel that it is a worthy cause to work on new ways to use paper. I explain just two of them here. First, considering the grand challenges of the mankind, I believe we really can fight the climate change by increasing the long-lasting usages of wood materials. In fact the only paper I managed to produce 2014 was in essence an effort to argue that when it comes to Carbon Capture and Storage, the production of wood materials makes more sense than any industrial scheme.

Then I have another philosophical and admittedly idealistic motivation why I am interested in paper as a raw material. I want to complement the ordinary technology push with low-tech examples of “market pull”. One way this can happen is through demonstrations of products that are made of paper, board or wood instead of metals or plastics. They stimulate new ideas and reveal new research challenges. Currently, a lot of that happens far away from here. I am involved in BioBusiness Arena because I believe that a lot will also happen here.

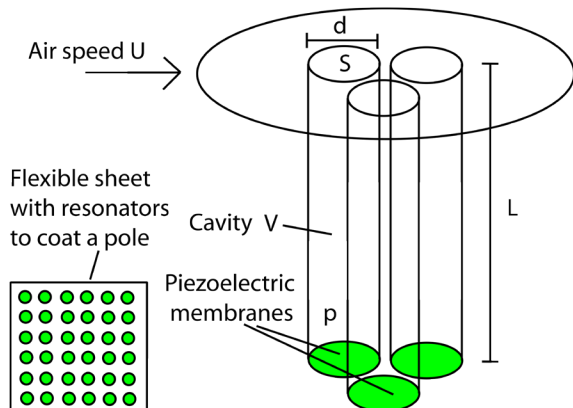
K. Niskanen, *“Lagra kol i form av trämaterial”* (Store carbon in wood materials), *Reflektion & Dialog*, Nr 6 (2014), 18-21.

## Modeling the extraction of wind power

Last year, we have been working on a paper about modeling the extraction of wind power from turbulence in wind by using a functional surface containing densely packed pipes, making up Pan flute resonators, with piezoelectric membranes at the bottoms.

When one blows in a Pan flute a tone is generated which depends on the length of the pipe. Different length gives different frequencies of the tones. At the neck the air is oscillating back and forth but at the bottom of the pipe where there is a wall, the air can not move and the pressure oscillate instead. If we put a piezoelectric membrane at the bottom instead of the wall it starts to oscillate when the pressure oscillates and energy can be harvested. Calculations show that using a pipe 3 millimeter long having a diameter of 1 millimeter we obtain a frequency of the tone of 28 kilo Hertz. This is above the human hearing range. We estimate the power harvested from one such flute to about 8 micro Watt at a free air speed of 9 meter per second. Densely packed, such flutes on flexible sheets attached around a pole then gives about 50 W per square meter at the same speed, which is an energy density comparable to solar cells. If our ongoing experiments turn out to confirm the result in the model this may open the door to environmental friendly wind power in the future.

Paper submitted.



Martin Olsen

PhD Student

Materials Physics

## Optimisation of wood fibre wall swelling and softening during refining

Mechanical pulp production in Sweden consumes approximately 5TWh/year of electric energy. The refining and grinding processes consume 80-90% of this energy. Since the price of electric energy is increasing and also the importance of environmental issues, a reduction in electricity consumption is crucial to mechanical pulp producers.

Swelling of wood fibres is an area that is rather unknown. There has been some research, but predominantly on chemical pulp fibres. Some properties that influence the wood fibres' ability to swell are temperature, pH, ionic form and the amount of charged groups. In order to obtain maximum swelled wood fibres, the wood matrix need to be softened.

The swelling properties of the wood matrix will be the main cause to where in the wood matrix the fibre separation will take place, and to a large extent, also influences the energy needed to separate the wood fibres from each other. Refining of fibres in different state of swelling gives arise to fibres with different optical and physical properties. By increasing the knowledge regarding swelling of wood fibres, it will be possible to control the degree of swelling, and where in the fibre wall the swelling occurs. Hence, swelling is a useful tool to modify the fibre/pulp properties throughout the different steps of the process, and to lower the energy consumption.

Compression stiffness studied with DMA (Dynamic Mechanical Analysis) on fibre pads is a promising method which offers the possibility to measure the softening and the swelling simultaneously as a function of temperature or pressure. We have further developed the equipment in order to make it more suitable for our fibre suspension samples and are now in the state of improving the methodology so that we will get reproducible data.



Helena Fjellström

Dr., Research engineer

High Yield Pulping Technology





*Photo: The new sample holder for fibre suspensions.*

## Analysis, identification and synthesis of natural active compounds

I was born in Iran in 1983. I received my BSC in chemistry from Tabriz University and MSC degree in organic chemistry from Tehran, Iran.

My research includes analysis, identification and synthesis of natural active compounds like pheromone. The goal of our project is to “develop efficient, commercial successful control methods for forest pest insects, based on semiochemicals”. The pesticides that are normally used have several drawbacks: no selectivity, ground water pollutant, pest insects resistance during long-term use. The usage of pheromones for trapping or disturbing pest insects has numerous advantages: the pheromone of one species affect only their behaviour, extremely low amounts of synthetic pheromone are needed, and it is harder for the insect to develop resistance to its own pheromone. They are from natural compound and no pollution.



Rizan Rahmani

PhD Student

Eco Chemistry

## Light scattering in paper

During 2014, my PhD studies have been focused on modelling light scattering in paper with radiative transfer theory, and in particular the inverse problem, i.e. estimating scattering, absorption and asymmetry parameters from bidirectional reflectance measurements.

To accurately determine these optical parameters is of great interest in product development, since they affect important properties such as whiteness, opacity and print quality. They are also of importance in e.g. printed electronics applications for optimizing the sintering process, and to reduce optical losses in thin solar cells. A full parameter estimation of scattering coefficient, absorption coefficient and asymmetry factor has however proved to be very difficult and highly sensitive to the quality of the input data. The main results of this study is new knowledge of how the complexity of the full parameter estimation problem can be reduced, and how the choice of measurement angles affects the accuracy in the estimation.

My work also includes studies of the angular distribution of fluorescence from paper. Fluorescent whitening agents are used to increase the whiteness of paper and textiles by absorbing UV radiation and re-emitting light in the visible part of the spectra. An increased knowledge of the angular distribution of fluorescence is highly valuable when determining the fluorescence efficiency and for predicting the visual appearance. With both measurements and Monte Carlo light scattering simulations, it is shown that the degree of fluorescence anisotropy depends on both the concentration of fluorophores and the angle of incident light.

The activities will be completed and published during 2015.



Niklas Johansson

PhD Student

Digital Printing Centre

## Light-weight Structural Composites from Fibre-based Materials: Reliability-based Design

Fibre from forests is one of the most promising materials for the future sustainable society because of its bio-renewability, cost efficiency, and adequate properties. However, in a market place, “sustainable” products are discussed in a much broader context, i.e., using less material, less energy, and, ultimately, less carbon foot prints in its life cycle, but with maintained end-use performance. One of the trends of our industry is trying to develop lighter basis-weight products with enhanced strength, but the approaches so far have met considerable challenges and had limited success. One reason is that enhancing strength at a lower basis weight without raising cost is increasingly difficult as our technologies have already matured over the years.



Amanda Mattsson

PhD Student

Complex Materials

This project aims at defining “true performance” of corrugated boards and boxes, developing a method to evaluate such performance, and then finding practical methods to maximise the true performance in pulping, papermaking and converting processes.

One of the fundamental questions raised in this project is “does stronger boxes always perform better than weaker boxes?” Field data and the literature showed otherwise: For example, the stronger box sometimes collapses earlier than the weaker box. In another example, a seemingly well-made box fails at an unexpectedly low load. Figure 1 shows a comparison of the strength distribution and lifetime distribution.

As can be seen, these two distributions have completely different shapes, even though the same material is tested. The big question is then how to express true performance, instead of just relying on the conventional strength. In this concern, we have developed a new scientific method to describe this complex performance, and introduced three new material parameters; durability, reliability, together with strength. These new concepts can be used as a product design tool to maximize the performance for the specific end-use application

and to save energy and materials and thus reduce cost in the manufacturing processes.

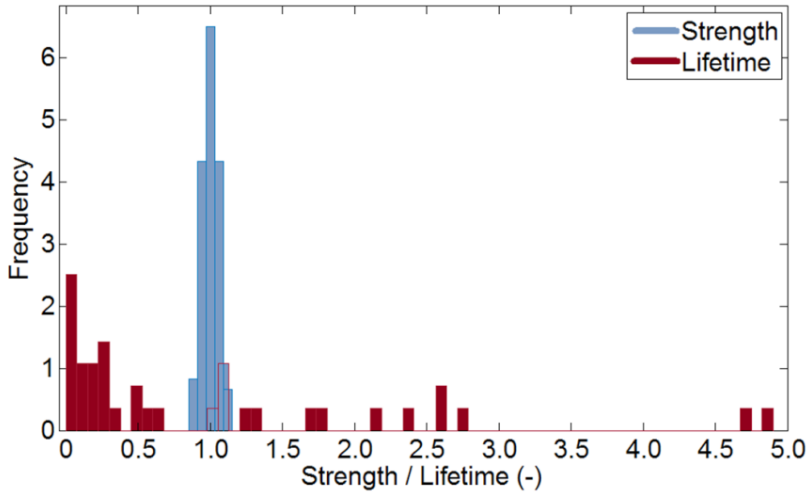


Fig. 1 Comparison of strength and creep lifetime distributions. In the x-axis, both strength and lifetime were normalized by their average values respectively.

## Bioenergy

Synthetic fuels, also known as the second generation bio-automotive fuels, can be produced via gasification and synthesis based on woody biomass and various residues. These second generation fuels open additional opportunities in opposition to the first-generation bio-automotive fuels (for instance bioethanol from food crops and biodiesel (RME)) – which already are commercialized. Beside the advantage of a wide selection of feedstock, the synthesis gas can be used for several applications such as power production and chemical products, not only liquid or gaseous fuels.



Kristina Göransson

Dr., Researcher

Bioenergy

I am a member of the Bioenergy research group at FSCN and our research is directed to the thermo-chemical conversion of biomass. As a resource for the energy research and for education of students, there is a BTL (biomass to liquids) laboratory at Mid Sweden University in Härnösand. The current objectives for the research group are to promote commercialization of advanced biofuels;

1. to develop a pilot-scale dual fluidised bed gasifier (DFBG) for production of a high quality syngas
2. to modelling the biorefinery concept when the gasifier is integrated into a mechanical pulp fibre line.

My present research area is tar-and-methane reforming aiming to improve the gasification technology by the use of catalytic bed material and internal tar- and methane reforming in the Mid Sweden University's DFBG. In order to significantly reduce the tar/CH<sub>4</sub> contents, the internal reformer (referred to as the FreeRef reformer) was developed for in-situ catalytic reforming, resulting in a patent application.

During 2014, I defended my doctoral thesis with the title "Internal Tar/CH<sub>4</sub> reforming in a biomass dual fluidised bed gasifiers towards fuel synthesis", published two papers, and become programme co-ordinator for the program leading to the B.S. Degree in Energy Engineering at Mid Sweden University. Additionally, I have been recently accepted to the "Program of the research



manager training at Mid Sweden University 2015-2017" (in Swedish "Meriteringsprogrammet") that aims to create favourable conditions for the recruitment of future research managers at the university.

#### **Publications in 2014**

- Göransson, K.; *"Internal tar/CH<sub>4</sub> reforming in biomass dual fluidised bed gasifiers towards fuel synthesis"*, Mid Sweden University Doctoral Thesis, ISSN 1652-893x:187, ISBN 978-91-87557-58-3 (2014)
- Söderlind, U., Zhang, W., Göransson, K. and Engstrand P.; *"A fluidized bed gasifier system"* Patent application: EP14163446.9, (2014, Europe)
- Göransson K., Söderlind U., Henschel T., Engstrand P. & Zhang W., *"Internal tar/CH<sub>4</sub> reforming in a biomass dual fluidised bed gasifier"*, Biomass Conversion and Biorefinery, doi:10.1007/s13399-014-0151-5, (2014)
- Göransson K., Söderlind U., Engstrand P. & Zhang W., *"An experimental study on catalytic bed materials in a biomass dual fluidised bed gasifier"*, Renewable Energy 81, 251-261, (2015)
- Göransson K, Söderlind U, Zhang W, *Catalytic Reduction of Tar/CH<sub>4</sub> by an Internal Reformer in a DFB Gasifier*, 22nd European Biomass Conference and Exhibition. Hamburg, Germany // 2014
- Göransson K, Söderlind U, Henschel T, Engstrand P, Zhang W, *Internal Tar/CH<sub>4</sub> Reforming by in a Biomass Dual Fluidised Bed Gasifier*, The 4th International Symposium on Gasification and Its Application (iSGA 2014), Vienna, Austria // 2014

## Research in surface and colloid engineering

On March 21 I defended my doctoral thesis titled "Fundamental characterization and technical aspects of a chelating surfactant", supervised by Professor Håkan Edlund and Professor Magnus Norgren. The thesis describes a surface active chelating agent and includes results regarding its pH-responsive solution behaviour, coordination and selectivity towards different metal ions, interaction with foaming agents, and recovery using ion flotation. The findings contribute to the understanding of the behaviour of chelating surfactants, which can be utilized in practical applications.



Ida Svanedal
Dr., Researcher
Surface and Colloid Engineering

In September, my colleagues and I had the opportunity to run neutron and x-ray reflectivity measurements for detailed studies of the solution behaviour of the chelating surfactant, at NIST (National Institute of Standards and Technology), USA. The trip was the beginning of a collaboration with Professor Adrian Rennie from Uppsala University, who is one of the most prominent experts on the subject.

I am also involved in a project about biocomposite material of graphite and cellulose nanofibres, CNF, led by Doctor Christina Dahlström, where I am studying the interaction between the two nanomaterials. The composite material is electrically conductive and can be used for energy storage in paper-based supercapacitors.

At the end of the year, I was accepted to "meriteringsprogrammet" at Mid Sweden University, starting April 2015, where I will focus on research regarding dissolution of cellulose in aqueous based solvents. Increased knowledge on this subject will enhance the possibilities of using wood-based cellulose in textile and composite materials.

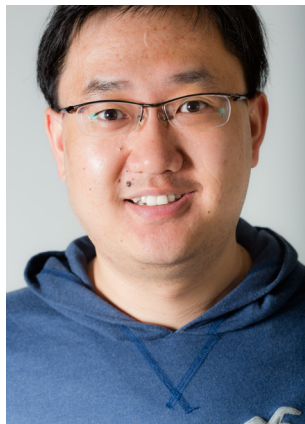
### Publications in 2014

- Svanedal, I. , Persson, G. , Norgren, M. & Edlund, H. (2014). *Interactions in Mixed Micellar Systems of an Amphoteric Chelating Surfactant and Ionic Surfactants*. Langmuir, vol. 30: 5, ss. 1250-1256.

- Svanedal, I. , Boija, S. , Norgren, M. & Edlund, H. (2014). *Headgroup interactions and ion flotation efficiency in mixtures of a chelating surfactant, different foaming agents and divalent metal ions*. Langmuir, vol. 30: 22, ss. 6331-6338.
- Svanedal, I. , Boija, S. , Almesåker, A. , Persson, G. , Andersson, F. , Hedenström, E. , Bylund, D. , Norgren, M. & et al. (2014). *Metal Ion Coordination, Conditional Stability Constants and Solution Behavior of Chelating Surfactant Metal Complexes*. Langmuir, vol. 30: 16, ss. 4605-4612.
- Svanedal, I; *Fundamental Characterization and Technical Aspects of a Chelating Surfactant*, Mid Sweden University, Doctoral Thesis ISSN 1652-893x: 179; ISBN 978-91-87557-39-2 (2014)

## Developing biocomposite materials from sustainable resources

I'm from China and I came to Sweden in 2010. I have a background of pulp & paper engineering from Tianjin University of Science and Technology and a master degree in macromolecular material from KTH. The research I've been involved in concerns applying induced-air-flotation (IAF) combined with surfactant to treat process water from mechanical pulping production, and applying cellulose dissolution to develop new biocomposite material.



Jiayi Yang

PhD Student

Surface and Colloid Engineering

While the pulp and paper industry are facing a shrinking margin and market, the challenge of using cellulose to create a more value-added product has been brought up on the table. Cellulose is continually investigated and commercially interested in the term of sustainable development from the pulp and paper industry and the agricultural sector. Based on the abundance, high strength, stiffness and biocompatibility, cellulose serves itself as one promising raw material in developing multi-functioning and value-added applications, such as in the packing, medical and biocomposite areas.

The primary scope of the current project, developing biocomposite materials from sustainable resources, is to investigate cellulose dissolution in an aqueous media. The cellulose macromolecule has amphiphilic characteristic and strong intra-, inter-molecule bonds, which makes the dissolution quite challenging but intriguing. Dissolving cellulose in aqueous solution opens up possibilities of using cellulose in broader areas. The other fundamental knowledge, such as the relationships between molecular characteristics and degree of solubility, and the interactions between solute and solvent, will be done to have a better understanding of the cellulose dissolution.

Furthermore, combining cellulose with some other biomacromolecules to create biomedical material is of enormous interest in the term of the unique properties of the composites. Since cellulose is a very important loading-bearing component in many organisms, the task is to adopt a suitable biomacromolecules, which has structural similarity with cellulose. The molecular structural

similarity does not only provide the kinetic compatibility of the polymer in the same solvent, but also excluded the negative impact on the physical and mechanical properties of the composite material. The ways to maintain the strong physical properties of cellulose and endow the other properties to the composites during mixing and regeneration also needs to be investigated. The attempt is using cellulose to carry the other biomolecules to reach some biomedical functions, such as drug release, anti-bacterial and diagnostic tool.

## Three Dimensional Fiber Networks

The focus of my research was to construct three dimensional fiber networks (3DFN). This was motivated by the idea that new applications may need a reconsideration of conventional fiber networks that are seen in ordinary paper products. Unlike typical papers where fibers are laid and oriented in-plane, an ideal 3DFN has a non-planar fiber orientation that may offer properties not seen in conventional papers, e.g. mechanical and mass/heat transport properties.

Fibers in water suspensions agglomerate easily and orient under shear. Hence, the challenges to make 3DFN was to distribute fibers in the space randomly in all directions, and to maintain these randomly oriented fibers until the structure is formed.



Majid Alimadadi

PhD Student

Complex Materials

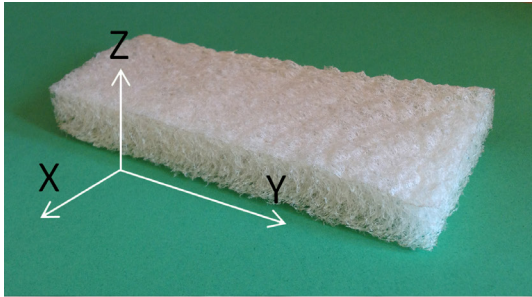
One possible way of tackling these challenges is to utilize foamed fiber suspensions. Foam has been used as a suspending medium for constructing low density structures for many years. Recently, extensive studies have been carried out to develop the understanding of foam-fiber interactions and to find the potential of this technology in new applications.

I adopted foam forming to create 3DFN. In 2014, I succeeded in making an ultra-low-density 3DFN out of refined TMP rejects and studied its mechanical properties. To the best of my knowledge the density of this structure is the lowest of a fibrous structure that ever made out of such fibers.

The 3DFN has extreme high bulk and of course 3D fiber orientation. These unique structures may offer special mechanical properties and mass transport properties suited for some hygiene products and composite materials. For example, in the area of short-fiber-reinforced composites, dispersing individual fibers uniformly is the most challenging task in order to ensure the reinforcement effect of fibers. Pre-forms made of the 3DFN may be a way to make fiber-reinforced polymer composites without flocculating fibers within the composites. Deformation recovery and extreme softness properties of 3DFN may offer additional comfort of, for example, bed cover and adult hygiene.

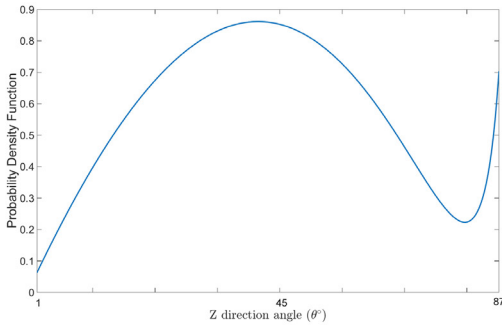


In 2014, I presented part of my results in the “2014 Progress in Paper Physics Seminar, Spanning Nano-to-Macro Scales of Research and Industry” in North Carolina, USA.



*Fig 1. A typical sample of the 3DFN.*

*Basis weight: 60 g/m<sup>2</sup>*



*Fig 2. Fiber orientation measurement of the 3DFN.*



*Fig 3. Prototype sample of the 3DFN as composite pre-form.*

## Appearance and optical properties of materials

My research background is in color imaging and my recent work has been directed towards spectral, angle resolved and imaging measurement system for optical characterization of materials.

The work involves a broad range of applications and problems such as bi-directional light scattering properties of materials, the impact of illumination and surrounding on the appearance of printed materials or image analysis of surface inhomogeneity and impurity in coatings.

In 2014, I was part of a larger research initiative within FSCN where we are aiming to define technology for large-scale R2R production systems of flexible electronics, which consists of deploying and patterning of multiple thin coating layers of conductive, semi-conducting and non-conducting materials. New flexible, functional and environmental-friendly materials and products manufactured in the effective productive apparatus of the Swedish forest industry could give rise to a significant improvement in product refinement and products with a higher customer value compared to the traditional products that are manufactured by the paper industry today. In this manufacturing process it will be necessary to have reliable tools for on-line quality control of individual coating layers and pattern definition. Surface characterization methods are equally important in optimizing current paper and board products for quality and material consumption as most of them will have high quality print, which increases the demand on parameters such as surface roughness, coating distribution and light scattering.

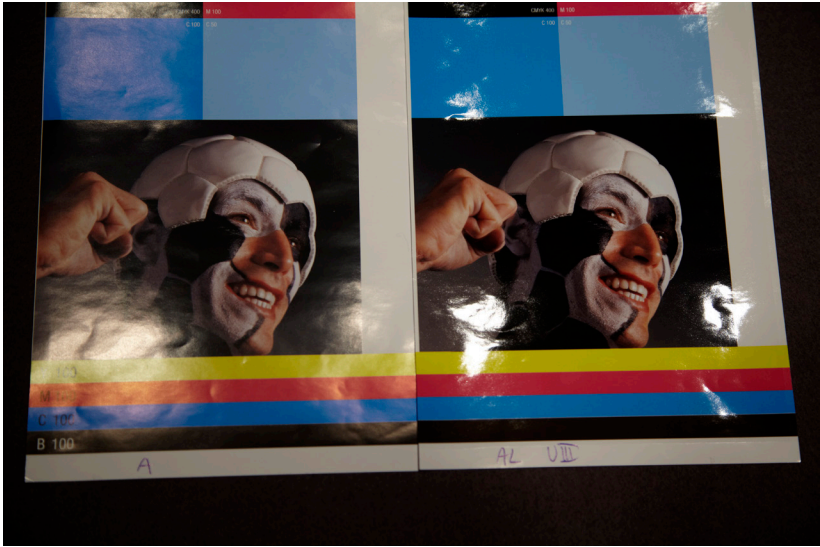
I am heading the Digital Printing Centre research group in Örnsköldsvik and im currently the subject leader of Graphic Arts technology at Mid Sweden University. During 2014 I was assistant supervisor for three PhD students. One of them, Thomas Öhlund, received his PhD in December 2014.



Mattias Andersson

Dr., Researcher

Digital Printing Centre



## Bioenergy and environmental issues

I am R&D engineer in the Bioenergy research group and PhD student in chemistry. I have worked in the energy area for more than 20 years. I have a passion for technology and technical systems, especially in relation to energy and energy systems. I also have a passion for environmental issues such as the CO<sub>2</sub> and the greenhouse gas threat.

The need for short and long time alternatives to fossil sources and sustainable solutions is vital. The major change in the Swedish energy system over the past 30 years is the rapid expansion of the bioenergy industry, which has increased from 40 TWh to 140 TWh and represent about one third of the energy consumption in the country. In Sweden, up to 80% of heat and 10% of electricity are produced from forest and industrial biomass residues and wastes. However, a minor part of the biofuel is produced for transportation which is responsible for the dominating GHG emissions.

A government target is set up as so-called “fossil-free transportation by 2030”. To reach the target, the key issue is to commercialize advanced biofuels through thermo-chemical conversion of biomass into syngas for the downstream production of fuels and chemicals, such as DME, FT fuels, methanol, ethanol, synthetic natural gas (SNG), hydrogen even(?) electricity etc.

My colleagues and I are gathering knowledge and skills in the DFBG allothermal gasification area to be able to convert biomass to chemicals e.g. automotive fuels. The research group is incorporated in the FSCN research centre and the gasification is a part of the value chain for “Biorefinery” in tune with the pulp fibre research activities at Mid Sweden University. Last year, my work has been to promote commercialisation of gasification techniques for production of advanced biofuels and the development of a novel type of internal reforming of tars and methane which is on the way to be patented. This novel idea is a combination of active bed material in a freeboard located catalytic function. Upcoming work is to continue promoting commercialisation of advanced automotive biofuels and chemicals and further optimize the FreeRef

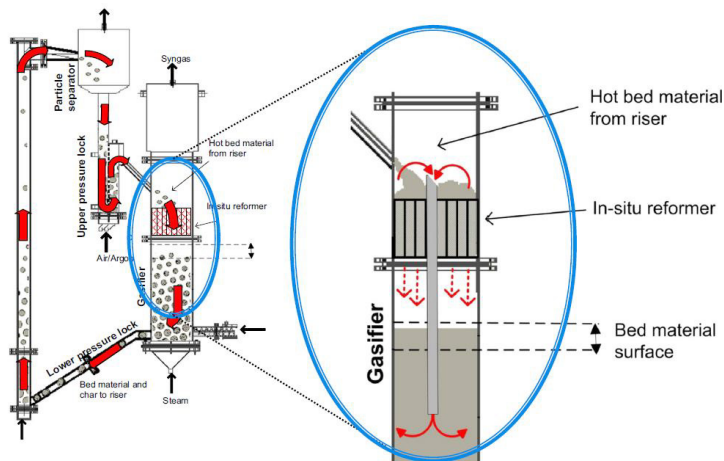


Ulf Söderlind

Research Engineer and PhD Student

Bioenergy

Fig. 1  
FreeRef  
reformer  
in the  
gasifier at  
Härnösand  
laboratory.



reformer, so my occupation will probably be even more thrilling in the future.

### Projects

- Bio2Fuels2030
- Miljöhorisont2020
- Fuel Flexibility
- Swedish Gasification Centre

### Publications in 2014

- Göransson, K.; *"Internal tar/CH<sub>4</sub> reforming in biomass dual fluidized bed gasifiers towards fuel synthesis"*, Doctoral Thesis, 187, Mid Sweden University (2014)
- He, J.; *"Gasification-based biorefinery for mechanical pulp mills"* Doctoral Thesis, 188, Mid Sweden University (2014)
- Söderlind, U., Zhang, W., Göransson, K. and Engstrand P.; *"A fluidized bed gasifier system"* Patent application: EP14163446.9, (2014, Europe)
- Jiang X., Song X., Chen Y. & Zhang W., *"Research on biogas production potential of aquatic plants"*, Renewable Energy, 69, p. 97-102, (2014)
- He, J., Engstrand, P. and Zhang, W., *"Bio-SNG production in a TMP mill in comparison with BIGCC"*, Energy Procedia 61, 2894-2897, (2014)
- Göransson K., Söderlind U., Henschel T., Engstrand P. & Zhang W., *"Internal tar/CH<sub>4</sub> reforming in a biomass dual fluidised bed gasifier"*, Biomass Conversion and Biorefinery, doi:10.1007/s13399-014-0151-5, (2014)
- Göransson K., Söderlind U., Engstrand P. & Zhang W., *"An experimental study on catalytic bed materials in a biomass dual fluidised bed gasifier"*, Renewable Energy 81, 251-261, (2015)

## Recovery of metal ions from aqueous solution using electrochemical and flotation methods

My research in the surface and colloid engineering group has focused on the recovery of copper and chelating ligand from aqueous solution using electrochemical and flotation methods. I started this research with an academic and career background in hydrometallurgy, material science, and waste treatment. This research has allowed me to continue to develop an understanding of fundamental and applied aspects of electrochemistry as well as aqueous and surface chemistry relevant to treat metal ions in process water and industrial effluent.

In this research, the electrochemical method was used to recover metal ion and chelating ligand from aqueous solution. Our approach was the electrodeposition of copper ions onto the cathode and the recovery of chelating ligands in a membrane cell. For this purpose, an electro MP-cell and micro flow-cell were installed in the lab. The electro MP-cell was applied to study the recovery of copper and chelating agent such as EDTA (ethylenediaminetetraacetic acid), DTPA (diethylenetriaminepentaacetic acid), and NTA (nitrilotriacetic acid). The phase composition and morphology of the electrodeposits was analyzed by X-ray Diffraction (XRD), X-ray Photoelectron (XPS), and scanning electron microscope (SEM). The electrodeposit consists of Cu, Cu<sub>2</sub>O, and CuO, which has tremendous applications in electronics, catalysis, sensors, supercapacitors, etc. In addition, the micro flow-cell was applied to study the recovery of copper and DTPA as a conventional chelating agent as well as 4-C<sub>12</sub>-DTPA (2-dodecyl diethylenetriaminepentaacetic acid) as a chelating surfactant. The effect of various parameters and the role of surface active property of 4-C<sub>12</sub>-DTPA on recovery was clarified. In this study, the performance of cell regarding the current efficiency and specific electricity consumption of recovery as well as average cell voltage, reduction potential and kinetics of recovery process for the complex solution were evaluated at studied experimental conditions.

Recently, a study conducted was to optimize the ion flotation efficiency of 4-C<sub>12</sub>-DTPA in mixtures with different foaming agents to remove selectively



Alireza Eivazhollagh

PhD Student

Surface and Colloid Engineering



$\text{Sr}^{2+}$ ,  $\text{Zn}^{2+}$ , and  $\text{Cd}^{2+}$  from aqueous solution. The results showed that ion floatation of each  $\text{Cd}^{2+}$  and  $\text{Zn}^{2+}$  was about 100%, whereas ion floatation of  $\text{Sr}^{2+}$  was around 80% in their optimized conditions.



## Fibre Network by Design: A New Project at FSCN

We are launching a new research project at FSCN. It is about our familiar material, fibre network. The fibre network is a fundamental structural unit in many biological tissues and organs, but also in industrial materials, such as nonwovens and paper. This time, we will investigate such networks used for hygiene products (e.g., tissues, towels/wipes, baby diapers, incontinent products, feminine products).

Why? Because hygiene products are, probably, one of the most important sectors in the future that will address society's challenges and needs for the next 30 years.



Tetsu Uesaka

Professor of Fibre-based Materials

Complex Materials

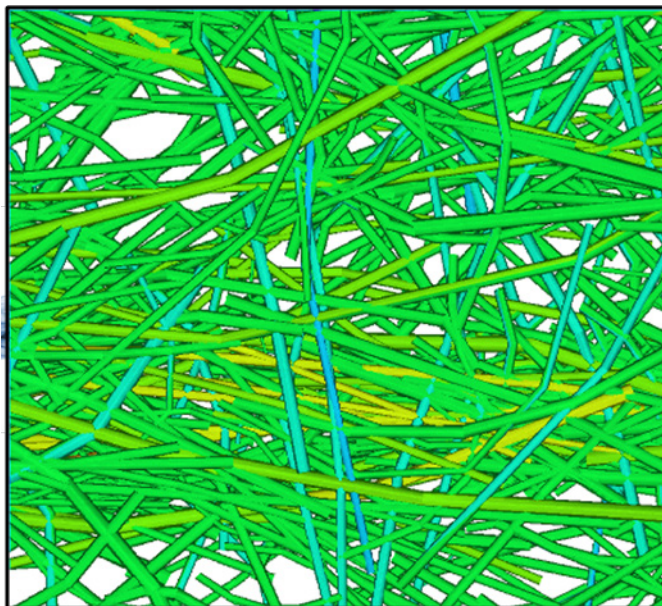
The society's challenges are;

1. ageing population in developed countries,
2. "women-on-the-go", and
3. a growing middle class in emerging countries.

They all need support for their active life style and daily health care. Today, hygiene is considered as the most important necessity for people, like one of the fundamental human rights.

What research do we do? Hygiene products are no longer a cheap alternative to textiles. It is a high performance product, such as recent sport clothes. It should provide good handfeel, comforts to the users, rapid and reliable transfer of body fluids, and environmental friendliness. In addition, these must be achieved with a minimum use of fibres (thinner and lighter). Fibre network is a basic structural framework of all hygiene products, and its structure has enormous impacts on mechanical and mass transport properties. The structure and performance now must be produced by design, rather than by accident. This involves the fundamental understanding of micro-mechanics and micro-fluidics taking place within the network and developing advanced product design tools (computational design tools).

This project is funded by the Knowledge Foundation as part of our research environment at Mid Sweden University. The industrial partners include companies of forest products, hygiene products, and chemical supplier sectors from three countries; Sweden, France and the USA.



*Fig 1. Micromechanics of virtual fibre network: S. Lindström, T. Uesaka, U. Hirm, 14th FRS, Oxford, UK*

## Eco-technology for valorization of natural resources

Organic chemistry is of utmost importance in the production of every day life products, e.g. paper, diapers, fuels, polymers, pharmaceuticals, fragrances, materials etc. In this context, it is a challenge to produce new selective synthetic chemistry for their preparation. Another challenge is to accomplish this in an environmentally friendly way that includes green chemistry parameters such as atom-economy, reduction of waste, toxins and the use of renewable resources. A difficulty encountered in chemical processes is the production of side products. This lowers the yield of the desired products as well as makes the isolation cumbersome. Moreover, significant waste is generated during and after the chemical processes. Thus, highly selective chemistry is required to reduce cost and make the processes “greener”. In the case of large-scale production (e.g. cellulose-based materials), the generation of toxic waste may have a very large impact on the environment and society. In addition, the use of harmful land organic solvents is not desirable. Here, we collaborate with engineers and material chemists for obtaining new designs of sustainable processes and assembly of bio-based materials. We also have a tight collaboration with the industry. Thus, bringing basic fundamental research into large-scale industrial applications.



Armando Córdova

Professor of Organic Chemistry

Organic Chemistry

The biochemical apparatus of the living cell has evolved over a billion years to a perfectly designed sustainable chemical system of catalytic networks. Thus, inspired by this eco-friendly biochemistry, we are undertaking a biological approach to the development of the new “green chemistry” selective processes for valorization of renewable resources (e.g. wood, cellulose, lignin, fatty acids). To accomplish this, we will use catalysis (a concept termed by Berzelius) preferably under eco-friendly conditions, e.g. “green” oxidants ( $O_2$ ,  $H_2O_2$ ), starting materials from renewable resources and non-harmful solvents (aqueous media, neat conditions). The catalysis platform is built on both small molecule catalysts and heterogeneous catalysts (e.g. organic molecules, metals and enzymes). In fact, the living cells use enzymes, metals and organic molecules as co-factors to accomplish the most perfect chemistry.

### Publications in 2014

- Deiana, L.; Jiang, Y.; Palo-Nieto, C.; Afewerki, S.; Incerti-Pradillos C.; Verho, O.; Tai, C.-W.; Johnston, E. V.; Córdova, A. *Combined heterogeneous metal/chiral amine: Multiple relay catalysis for versatile eco-friendly synthesis*, *Angew. Chem. Int. Ed.* 2014, 53, 3447.
- Hafrén, J.; Córdova, A. *Applied and eco-friendly catalysis for wood and fiber modifications*. In “Industrial Biorenewables: A practical viewpoint”, Domínguez de

María, P. Ed. John Wiley & Sons Inc., Hoboken, New Jersey. (2015).

- Kohls, H.; Anderson, M.; Dickerhoff, J.; Weisz, K.; Córdova, A.; Berglund, P.; Brundiek, H.; Bornscheuer, U. T.; Höhne, M. *Selective access to all four diastereomers of an 1,3-amino alcohol by combination of a keto reductase- and an amine transaminase-catalysed reaction*. Adv. Synth. Cat. 2015, In press.
- Chao, X.; Deiana, L.; Afewerki, S.; Incerti-Pradillos, C.; Córdova, O.; Peng, G.; Córdova, A.; Hedin, N. *The Use of Porous Pd<sup>2+</sup>-polyimine in Cooperatively-catalyzed Highly Enantioselective Cascade Transformations*. Adv. Synth. Cat. 2015, Early view.
- Afewerki, S.; Ma, G.; Ibrahim, I.; Liu, L.; Sun, J.; Córdova, A. *Highly Enantioselective Control of Dynamic Cascade Transformations by Dual Catalysis: Asymmetric Synthesis of Poly-Substituted Spirocyclic Oxindoles*. ACS Catal. 2015, 5, 1266.
- Mridha, M.; Ma, G.; Palo-Nieto, C.; Córdova, A. *Application of Highly Stereoselective Co-Catalytic Direct Aldol Reaction on Water for the Concise Total Synthesis of D-lyxo-Phytospingosine*. Int. Conf. on Chem, Chem. Eng. and Mat. Sci. 2014, pp 174-177. ISBN 978-161804-253-8.
- Jiang, L.; Dziejczak, P.; Spacil, Z.; Zhao, G.-L.; Nilsson, L.; Ilag, L.; Córdova, A. *Abiotic synthesis of amino acids and self-crystallization under prebiotic conditions*. Sci. Rep. 2014, 4, 6769; www.nature.com, DOI:10.1038/srep06769 (2014).
- Santoro, S.; Deiana, L.; Zhao, G.; Lin, S.; Himo, F.; Córdova, A. *Mechanism of Palladium/Amine Co-Catalyzed Carbocyclization of Aldehydes with Alkynes and its Merging with Pd Oxidase Catalysis*, ACS Catal. 2014, 4, 4474.
- Deiana, L.; Ghisu, L.; Afewerki, S.; Verho, O.; Johnston, E. V.; Hedin, N. Bacsik, Z., Córdova, A. *Enantioselective Heterogeneous Synergistic Catalysis for Asymmetric Cascade Transformations*. Adv. Synth. Cat. 2014, 356, 2485.
- Anderson, M., Afewerki, S., Berglund, P., Córdova, A. *Total Synthesis of Capsaicin Analogues from Lignin-Derived Compounds by Combined Heterogeneous Metal, Organocatalytic and Enzymatic Cascades in One Pot*, Adv. Synth. Cat. 2014, 356, 2113.
- Deiana, L., Ghisu, L., Córdova, O., Afewerki, S., Zhang, R., Córdova, A. *Efficient and Highly Enantioselective Aerobic Oxidation–Michael–Carbocyclization Cascade Transformations by Integrated Pd(0)-CPG Nanoparticle/Chiral Amine Relay Catalysis*, Synthesis 2014, 46, 1303.

## Patents

- U.S. Provisional Patent Application Serial No. 61/971,106 *"Efficient Synthesis of Amines and Amides from Alcohols and Aldehydes by using Cascade Catalysis"* Inventors: Armando Córdova, Stockholm, Sweden, Per Berglund, Stockholm Sweden, Mattias Anderson, Stockholm Sweden, Samson Afewerki, Sundsvall.
- U.S. Provisional Patent Application Serial No. 62/072,774 *"A Mild Catalytic Reduction of C-O Bonds Using a Recyclable Catalyst System"* Inventors: Armando Córdova, Stockholm, Sweden, Carlos Palo-Nieto, Sundsvall, Sweden, Samson Afewerki, Sundsvall, Sweden.
- U.S. Provisional Patent Application. *"Direct mild synthesis of amines from aldehydes by heterogeneous metal-catalysis and one-pot three-component synthesis of amides from aldehydes"* Inventors: Armando Córdova, Stockholm, Sweden, Carlos Palo-Nieto, Sundsvall, Sweden, Samson Afewerki, Sundsvall, Sweden.



## Organic chemistry

My research focus can shortly be summarized as development of innovative and eco-friendly applied chemistry. Organic chemistry is used as a tool to address three main topics:

- Development and application of heterogeneous catalysts.
- Valorization of biomasses such as lignin.
- Modification of cellulose, nanocellulose and different types of lignocellulosic fibers

Environmentally benign chemistries for the depolymerization of lignin have been developed. The integration of heterogeneous organo-, enzyme and metal-catalysis works as platform for this purpose. The use of heterogeneous metal catalysis can be considered eco-friendly since it allows for recycling and preventing leaching and contamination of the metal catalyst and the use of natural occurring metal-free catalysis (enzyme, amino acids, organic acids) is also environmentally friendly. At this moment the newly developed methodology that will allow for the depolymerization of lignin and further employ the versatile building blocks of lignin as source for fine chemicals, synthesis of natural products and biofuel is undergoing patent process.



Samson Afewerki

Dr., Researcher

Organic Chemistry

The research also includes environmentally friendly development and design of new methods for the modification of cellulosic materials to a controlled approach to change its properties such as hydrophobic/water resistant, mechanically stronger (by including cross-linking), antibacterial etcetera. This has been done in conjunction with industry and they want to patent the developed process.

### Patents

1. U.S. Provisional Patent Application Serial No. 61/971,106 *"Efficient Synthesis of Amines and Amides from Alcohols and Aldehydes by using Cascade Catalysis"* Inventors: Armando Córdova, Stockholm, Sweden, Per Berglund, Stockholm Sweden, Mattias Anderson, Stockholm Sweden, Samson Afewerki, Sundsvall, Sweden.
2. U.S. Provisional Patent Application Serial No. 62/072,774 *"A Mild Ca-*



*talytic Reduction of C-O Bonds Using a Recyclable Catalyst System"*  
Inventors: Armando Córdova, Stockholm, Sweden, Carlos Palo-Nieto, Sundsvall, Sweden, Samson Afewerki, Sundsvall, Sweden.

- U.S. Provisional Patent Application. "*Direct mild synthesis of amines from aldehydes by heterogeneous metal-catalysis and one-pot three-component synthesis of amides from aldehydes*" Inventors: Armando Córdova, Stockholm, Sweden, Carlos Palo-Nieto, Sundsvall, Sweden, Samson Afewerki, Sundsvall, Sweden.

#### Publication in 2014

- Anderson, M.; Afewerki, S.; Berglund, P.; Córdova, A. *Total synthesis of capsaicin analogues from lignin-derived compounds by combined heterogeneous metal, organocatalytic and enzymatic cascades in one pot.* Adv. Synth. Catal. 2014, 356, 2113.
- Deiana, L.; Jiang, Y.; Palo-Nieto, C.; Afewerki, S.; Incerti-Pradillos, C. A.; Verho, O.; Tai, C.-W.; Johnston, E. V.; Córdova, A. *Combined Heterogeneous Metal/Chiral Amine: Multiple Relay Catalysis for Versatile Eco-Friendly Synthesis.* Angew. Chem. Int. Ed. 2014, 53, 3447.
- Deiana, L.; Ghisu, L.; Afewerki, S.; Zhang, R.; Córdova, A. *Efficient and Highly Enantioselective Aerobic Oxidation/Michael/Carbocyclization Cascade Transformations by Integrated Pd(0)- CPG nanoparticle/Chiral Amine Relay Catalysis.* Synthesis, 2014, 46, 1303.
- Deiana, L.; Ghisu, L.; Afewerki, S.; Verho, O.; Johnston, E.; Hedin, N.; Bacsik, Z.; Córdova, A. *Enantioselective Heterogeneous Synergistic Catalysis for Asymmetric Cascade Transformations.* Adv. Synth. Catal. 2014, 356, 2485.
- Afewerki, S.; Ma, G.; Ibrahim, I.; Lui, L.; Sun.; Cordova, A. *Highly Enantioselective Control of Dynamic Cascade Transformations by Dual Catalysis: Asymmetric Synthesis of Poly-Substituted Spirocyclic Oxindoles.* Adv. Synth. Catal. 2015, 5, 1266.
- Afewerki, Samson: *Development of Catalytic Enantioselective C-C bond-forming and Cascade Transformation by merging Homogenous or heterogeneous Transition Metal Catalysis with Asymmetric aminocatalysis*, Mid Sweden University, Doctoral Thesis ISSN 1652-893x:206, ISBN 978-91-87557-90-3 (2014)

## Research on graphene and energy storage

I very much enjoy bringing new ideas to reality. My background is in colloid chemistry and papermaking, but with time I have been working more and more with research in nano-technology. I have taken a particular interest in graphene. Graphene is a one molecular layer thick carbon material, which has many uses.

It has been a great pleasure to be a part of starting and presently executing the KEPS, MODULIT and LION projects. All three projects are aiming at solving energy storage problems and graphene is part of the solution in all of them.

In my forth project, 2D INKS, we are trying to use graphene to make electrically conducting printing inks. These projects also, in one way or another, have cellulose as a common denominator.



Sven Forsberg

Lic., Researcher

Materials Physics

### Publications in 2014

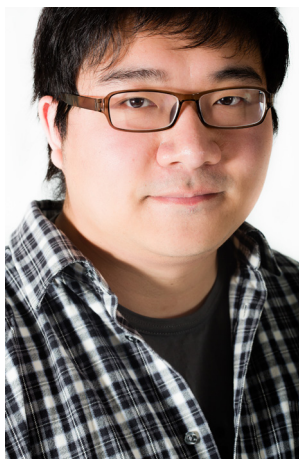
- Zhang, R. , Alecrim, V. , Hummelgård, M. , Andres, B. , Forsberg, S. , Andersson, M. & Olin, H. (2015). *Thermally reduced kaolin-graphene oxide nanocomposites for gas sensing*. Scientific Reports, vol. 5, ss. Art. no. 7676
- Andersson, H. , Manuilskiy, A. , Gao, J. , Lidenmark, C. , Sidén, J. , Forsberg, S. , Unander, T. & Nilsson, H. (2014). *Investigation of Humidity Sensor Effect in Silver Nanoparticle Ink Sensors Printed on Paper*. IEEE Sensors Journal, vol. 14: 3, ss. Art. no. 6615915
- Andres, B. , Forsberg, S. , Dahlström, C. , Blomquist, N. & Olin, H. (2014). *Enhanced electrical and mechanical properties of nanographite electrodes for supercapacitors by addition of nanofibrillated cellulose*. Physica status solidi. B, Basic research, vol. 251: 12, ss. 2581-2586.

## Paper plasticization

I have a Master degree in pulp and paper engineering and now I'm working with fibre and paper modification. Developing novel materials with totally new properties out of traditional raw materials offers great opportunities to take the advantages of existing knowledge and technology. But there are also great challenges to overcome certain inherent properties of sustainable materials like wood in order to replace traditional fossil based products. Wood containing composites have been successfully introduced to large variety of application like WPC (Wood Plastic Composites) panels. However, despite the plastic substitution, these materials still contain a lot of non-renewable raw materials.

The object of our research is to use only lignocellulosic materials, such as plasticized cellulose, to produce composites. The key point to be able to produce sheet like materials is to pre-modify the fibre materials. We are looking for different improvements such as lighter, stronger or more ductile materials. As an example, we study the possibility to produce laminated cellulosic composite by partial dissolution of cellulose in sheet materials with NaOH/urea solutions. The resulting composites show an improved stiffness which might be interesting for certain applications.

We are also studying the mechanical properties improvement of sheet materials produced from switchable ionic liquid (SIL) treated high temperature chemithermomechanical pulp (HT-CTMP). The investigations indicate the treatment can change the lignin and hemicellulose content in the fibre and the zero-short span tests show that lab sheets produced from treated and untreated materials differ significantly in their mechanical properties.



Ran Duan
PhD Student
Surface and Colloid Engineering



## Development of CTMP technologies

During 2014, I have been involved in several research projects in the area of high yield pulping technology. The projects have mainly focused on developing new technologies, especially for manufacturing of fold in boxboard and liquid packaging board.

In the project **“Low energy CTMP for paperboard”** we gained useful knowledge on energy efficient production on spruce CTMP. By applying HT technology (high-temperature) in combination with suitable refiner segments, it was possible to achieve an energy reduction by up to 40 %. By adopting so called multilayer technique, addition of starch/CMC, it was proved that even very weak HT-mechanical pulps can be used in high quality board production without compromising the end-use properties. The project was carried out mostly in pilot plant scale and as mill trials in cooperation with SCA Östrand and Stora Enso. The results in this project was presented at the International Mechanical Pulping Conference in Helsinki in June.



Gunilla Pettersson

Dr., Researcher

High Yield Pulping Technology

The project **“Advanced HYP for paperboard”** started in late 2014. Here, the project goal is to develop and demonstrate techniques, based on hardwood (CTMP) particularly birch, to be used in manufacturing of paperboard. The total energy consumption in refining of such hardwood CTMP should be lower than 700 kWh/ton, to be compared to about 1200 kWh/ton in standard CTMP manufacturing. The CTMP should preferably be used in middle plies in a paperboard, which will offer an opportunity to reduce grammage with given bending stiffness and improve brightness as well as surface smoothness in final products. At present, a main obstacle to use birch CTMP in some paperboard qualities, e.g. liquid board, is a too high content of extractives. These can cause problems with smell and taste from the packaging material or, in the worst case, from the packed products. Improved techniques have to be developed to make birch CTMP an attractive complement to spruce CTMP for the paperboard industry. Recently, a full scale test-trial at SCA Östrand were performed, where HT-CTMP from birch was manufactured. Analyses of

extractives from different positions in the mill were examined. A pilot plant trial at Valmet has also been carried out together with Stora Enso Research, where LC-grinding on different birch pulps were studied.

In a project founded by Nils and Dorthi Troëdsson Research Foundation, we intend to work with market pulp. Based on a pre-study, a realistic goal for the project is to double the strength properties (tensile and Z-strength) for market pulp made of CTMP (wood yield about 90%). A successful outcome of the project may make it possible to compete successfully, with regarding both cost and quality, with chemical market pulp (wood yield about 50%) in manufacturing of paper products with such high strength requirements that today's high-yield pulp is not an interesting option.

#### **Publications in 2014**

- Gunilla Pettersson, Hans Höglund, Sven Norgren, Jessica Sjöberg, Frank Peng, Hans Hallgren, Anders Moberg, Carl-Henrik Ljungqvist, Jörgen Bergström and Daniel Solberg; *Strong and bulky paperboard from surface modified CTMP, manufactured at low energy*, Nordic Pulp Paper Res J 30(2)
- Sven Norgren, Gunilla Pettersson, Hans Höglund; *High strength papers from high yield pulp*, In Proceedings of International Mechanical Conference Helsinki, Finland.

## New cellulosic materials

My research interest covers the area of surface and colloid chemistry; materials and phenomena. Specifically I focus on wood polymers and related conventional and novel processes to convert them to functional materials. I am also interested in special surfactants with additional features like metal chelation, and polyelectrolytes.

I am the group leader of Surface and Colloid Engineering and hold a PhD in physical chemistry from Lund University, with Prof Björn Lindman as main supervisor.

In late 2001, I defended my PhD thesis “On the physical chemistry of kraft lignin. Fundamentals and applications”. The project was initiated and initially funded by SCA, with Göran Annergren and Dr Lars Wågberg as industrial advisors from the start.

I was involved in Future Resource-Adapted Pulp Mill project led by STFI-Packforsk (Innventia) and the development of the LIGNOBOOST process, later commercialized by Metso Power/Valmet. I am co-inventor of one of the patents that is the cornerstone for good precipitation yield and filterability of the kraft lignin.

In 2004, I was awarded the Alf de Ruvo stipend for my achievements in the area of the physical chemistry of lignin.

During 2004-2005, I did my post doc at the Australian National University, Department of Applied Mathematics in Canberra with Prof Vince Craig.

During 2007-2009 I worked 50% as a researcher at the Royal Institute of Technology, Department of Fiber and Polymer Technology together with Professor Lars Wågberg.

During 2009-2010 I worked part time for Mid Sweden University's innovation office, MIUN Innovation.



Magnus Norgren

Professor of Chemical Engineering

Surface and Colloid Engineering



In 2010, I was appointed full professor of chemical engineering at Mid Sweden University.

During 2012, I was on leave of absence one year, working as the CEO of the spin-off company ChemseQ International AB, where I am one of the co-founders.

#### **Publications in 2014**

- Zasadowski, D. , Strand, A. , Sundberg, A. , Edlund, H. & Norgren, M. (2014). *Selective purification of bleached spruce TMP process water by induced air flotation (IAF)*. *Holzforschung*, vol. 68: 2, ss. 157-165.
- Zasadowski, D. , Yang, J. , Edlund, H. & Norgren, M. (2014). *Antisolvent precipitation of water-soluble hemicelluloses from TMP process water*. *Carbohydrate Polymers*, vol. 113, ss. 411-419.
- Boija, S. , Almesåker, A. , Hedenström, E. , Bylund, D. , Edlund, H. & Norgren, M. (2014). *Determination of conditional stability constants for some divalent transition metal ion-EDTA complexes by electrospray ionization mass spectrometry*. *Journal of Mass Spectrometry*, vol. 49: 7, ss. 550-556.
- Svanedal, I. , Persson, G. , Norgren, M. & Edlund, H. (2014). *Interactions in Mixed Micellar Systems of an Amphoteric Chelating Surfactant and Ionic Surfactants*. *Langmuir*, vol. 30: 5, ss. 1250-1256.
- Svanedal, I. , Boija, S. , Norgren, M. & Edlund, H. (2014). *Headgroup interactions and ion flotation efficiency in mixtures of a chelating surfactant, different foaming agents and divalent metal ions*. *Langmuir*, vol. 30: 22, ss. 6331-6338.
- Svanedal, I. , Boija, S. , Almesåker, A. , Persson, G. , Andersson, F. , Hedenström, E. , Bylund, D. , Norgren, M. & et al. (2014). *Metal Ion Coordination, Conditional Stability Constants and Solution Behavior of Chelating Surfactant Metal Complexes*. *Langmuir*, vol. 30: 16, ss. 4605-4612.
- Duan, R. , Ibrahim, I. , Edlund, H. & Norgren, M. (2014). *Acid-Catalyzed Synthesis of Foamed Materials from Renewable Sources*. *Industrial & Engineering Chemistry Research*, vol. 53: 45, ss. 17597-17603.
- Norgren, M. & Edlund, H. (2014). *Lignin: Recent advances and emerging applications*. *Current Opinion in Colloid & Interface Science*, vol. 19, ss. 409-416.

## Energy efficiency in mechanical pulping

My research is focused on solving the key bottle necks related industrial problems to high yield pulping both regarding energy and process efficiency as well as regarding broadening the range of products where these pulps can be utilized.

I am trying to utilize my long experience from the pulp and paper industry ranging from forestry issues via pulping to papermaking and conversion to products in order to design a biorefinery-related project approach. During the end of 2014 we started FORIC (Forest as a resource industrial research college), where we want to widen the use of forest based fibres in general with focus on the increased use of high yield pulp fibres. I believe that in the long run high yield pulping processes will increase in importance due to outstanding process efficiency (yield), successively improved energy efficiency (50% reduction within 10 years), lower surface weight at same functional properties, better possibilities to extract high value green chemicals and also probably better specific fibre strength.



Per Engstrand

Professor of Mechanical Pulping

High Yield Pulping Technology

The major part of my research is related to our research profile e2mp (energy efficient mechanical pulping) where we published some of the recent work at the International Mechanical Pulping Conference in Helsinki, June 2014. A major breakthrough with regard to 15% reduced electricity consumption in demo-scale at preserved functional product properties was shown by Erik Nelsson et al, industrial PhD Student at FSCN and project leader at Holmens research project *"Improved energy efficiency in thermo-mechanical pulping through co-optimization of intensity by segment design and wood softening by sulfonation"*. Fundamental wood material property findings published by Dr. Birgitta Engberg et al in the paper *"Mechanical properties of sulphonated wood in relation to wing refiner properties"* shows a track to further improve energy efficiency. My colleague Prof. Anders Karlström at Chalmers who published many papers dealing with high consistency refining during 2014 also published a paper *"Can we increase the proportion of electrical energy into fibre development in existing HC-refiners?"* on how the proportion of efficiently used energy can be increased by means improved refiner control. One of the major approaches we are using to reduce energy consumption is to understand how to increase the proportion of LC refining at the same time as we are reducing the normally less efficient HC refining a key to this is to understand *"LC Refining Intensity In The Light Of Forces On Fibres"* a paper describing this was published by Dr. Jan-Erik Berg et al. A new measurement method published by Dr. Louise Logenius et al *"A sustainable analysis of sulphonic acid content in CTMP pulps"*

will help to better perform and understand fundamental performance of thermo and chemimechanical pulping processes as detailed information of sulphonic groups is very important. The overall goal for e2mp is to in a 10-year period find ways to reduce the electric energy consumption in TMP and CTMP processes by 50% compared to best available technology (BAT). This research started 2011 and results achieved until 2014 has already proven 15% in demoscale. As there are several lab, pilot and further demoscale tests just recently performed and underway I actually believe that it will be possible to reach this goal by 2021, provided that the research is financed properly.

In refining the relation between surface increase during defibration and fibrillation is generally inefficient in relation to the utilized electricity, about 5% is generally reckoned to be utilized to create surfaces while the rest correspond to losses. In modern pressurized high consistency refining, however, about 70% of the generated heat is recovered as steam. As this steam is the major source of heat for drying of paper or paperboard, improved electric energy efficiency may result in an increased need for externally generated heat. An environmentally friendly and sustainable way to solve this problem is discussed in the paper *"Bio-SNG production in a TMP Mill in comparison with BIGCC"* by Dr. Jie He et al, he defended his doctoral thesis in 2014. This work is just as the initially mentioned energy efficiency research, connected to our TIE strategy i.e., transforming the industrial ecosystem as in the case of Forest as a resource (FORE). Based on this study, I believe that it in the future probably will be beneficial to utilize the 30% of the biomass related to branches and tops that today largely is not collected together with smarter utilization of bark and reject streams to generate electricity based on combined gas and steam turbines as well low pressure steam for drying of paper. Investors representing industry as well as government must however learn to recognize a more long-term focus compared to what is common today. A prerequisite is of course longterm Swedish energy and forest bio-resource politics combined with improved awareness regarding the future needs for sustainable products based on pulp fibres as high yield pulp fibres, bio-based energy and green chemicals, all replacing the present fossil based alternatives. A key feature in our pilot plant-based research in the field of gasification of biomass is related to Dr. Kristina Göransson's paper *"Internal tar/CH4 reforming in a biomass dual fluidised bed gasifier"*. Here, a suggestion to minimize the tar and methane contents of the syngas at the same time maximizing hydrogen and carbon monoxide without external expensive equipments. But for utilizing biobased substitute natural gas in turbines the bio-based syngas can also be used to produce fuels as DME and Methane, which means a future flexibility possibility. Kristina defended her doctoral thesis in 2014 and the internal tar/CH4 reforming methodology has a patent pending.

As some of the fine particles produced during refining in CTMP and TMP processes are actually not improving the properties of the final paper, board or tissue products, but rather the opposite, we have studied ways to further process this fines material to nanoligno-cellulose (NLC). Sinke Henshaw Osong published the following papers discussing these possibilities; *"Paper strength improvement by inclusion of nano-ligno-cellulose to Chemi-thermomechanical pulp"*, *"Development of nano-ligno-cellulose*

*produced from mechanical pulp*" and "*Crill: A novel technique to characterize nano-ligno-cellulose*". In short, it seems to be possible to produce improved fibrillar materials that have quite good bonding/adhesion potential and right now we are studying the possibilities of producing NLC-types that could replace the quite expensive CMC when using layer-by-layer technologies to build for instance extremely stiff CTMP-based paperboard with low surface weight.

Peroxide chemistry is an important tool both regarding lignin preserving bleaching and regarding improving energy efficiency in chip-refining due to optimized fibre separation as well as by means of increased fibre charge level. Karin Walter published the paper "*Acid Hydrogen Peroxide Treatment of Norway Spruce TMP: The Effect of an Extended pH Range when Catalyzed by Free Ferrous and Free or EDG/EDTA-Chelated Ferric Ions*" describing aspects of how the TMP process efficiency could be improved. Furthermore, Anette Karlsson published the paper "*Strategies to reduce heat-induced darkening for enhanced bleachability of mechanical pulps*" where we try to explain how to minimize the darkening during refining in order to reduce peroxide consumption to certain brightness level or in order to maximize the level of brightness. Sofia Enberg published the paper "*Some causes of formation of colour during storage of hydrogen-peroxide bleached Norway spruce mechanical pulp*" describing fundamental aspects on how to minimize brightness losses from bleach plant to paper machine. Anette was an industrial PhD student at SCA R&D Centre and Karin was an industrial PhD student at AkzoNobel (Eka Chemicals). They defended their doctoral thesis by the end of 2013 and Sofia, industrial PhD student of Norske Skog, defended her doctoral thesis in 2014. It should also be mentioned that research work regarding fundamentals of crack propagation in wood chips and its relation to the possibilities of reducing energy consumption as well as capacity increase during TMP and CTMP production has continued. By the end of 2010 we (Prof. Øivind Gregersen NTNU, Dr. Lisbeth Hellström, Prof Per Gradin and Prof Torbjörn Carlberg MIUN) started the company CCT AB in holding the patents in the area. During the 2013-14, a full scale test of the method was performed that validated most of the earlier pilot and demoscale data. There are however, still some technical problems to resolve regarding the mechanical strength.

#### **Publications in 2014**

- Osong, S. H. , Norgren, S. & Engstrand, P. (2014). *Paper strength improvement by inclusion of nano-ligno-cellulose to Chemi-thermomechanical pulp*. Nordic Pulp & Paper Research Journal, vol. 29: 2, pp. 309-316.
- Karlsson, A. , Paulsson, M. , Engstrand, P. & Hedenström, E. (2014). *Strategies to reduce heat-induced darkening for enhanced bleachability of mechanical pulps*. Appita journal, vol. 67: 1, pp. 50-57.
- Walter, K. , Paulsson, M. & Engstrand, P. (2014). *Acid Hydrogen Peroxide Treatment of Norway Spruce TMP: The Effect of an Extended pH Range when Catalyzed by Free Ferrous and Free or EDG/EDTA-Chelated Ferric Ions*. Journal of wood chemistry and technology, vol. 34: 2, pp. 135-155.

- Enberg, S. , Rundlöf, M. , Paulsson, M. , Axelsson, P. , Eriksen, O. & Engstrand, P. (2014). *Some causes of formation of colour during storage of hydrogen-peroxide bleached Norway spruce mechanical pulp*. Nordic Pulp & Paper Research Journal, vol. 29: 2, pp. 356-366.
- Enberg, S. , Rundlöf, M. , Paulsson, M. , Axelsson, P. , Eriksen, O. & Engstrand, P. (2014). *The influence of process waters on optical properties during storage of hydrogen-peroxide bleached Norway spruce mechanical pulp*. Nordic Pulp & Paper Research Journal, vol. 29: 2, pp. 344-355.
- Osong, S. H. , Norgren, S. , Engstrand, P. , Lundberg, M. & Hansen, P. (2014). *Crill: A novel technique to characterize nano-ligno-cellulose*. Nordic Pulp & Paper Research Journal, vol. 29: 2, pp. 190-194.
- Göransson, K. , Söderlind, U. , Henschel, T. , Engstrand, P. & Zhang, W. (2014). *Internal tar/CH<sub>4</sub> reforming in a biomass dual fluidised bed gasifier*. In Proceeding of 4th International Symposium on Gasification and its Applications.
- Berg, J. , Sandberg, C. , Engberg, B. & Per, E. (2014). *LC Refining Intensity In The Light Of Forces On Fibres*. In International Mechanical Pulping Conference, IMPC 2014. Espoo
- Engberg, B. , Logenius, L. & Engstrand, P. (2014). *Mechanical properties of sulfonated wood in relation to wing refiner properties*. In International Mechanical Pulping Conference, IMPC 2014. Espoo :
- Logenius, L. , Fjellström, H. & Engstrand, P. (2014). *A sustainable analysis of sulfonic acid content in CTMP pulps*. In International Mechanical Pulping Conference, IMPC 2014. Espoo
- Osong, S. H. , Norgren, S. , Engstrand, P. , Lundberg, M. & Hansen, P. (2014). *Development of nano-ligno-cellulose produced from mechanical pulp*. In International Mechanical Pulping Conference, IMPC 2014.
- Nelsson, E. , Sandberg, C. , Svensson-Rundlöf, E. , Muhic, D. , Rohden, L. , Engberg, B. A. & Engstrand, P. (2014). *Improved energy efficiency in thermomechanical pulping through co-optimization of intensity by segment design and wood softening by sulfonation*. In International Mechanical Pulping Conference, IMPC 2014.
- Karlström, A. , Hill, J. , Ferritsius, O. , Ferritsius, R. & Engstrand, P. (2014). *Can we increase the proportion of electrical energy into fibre development in existing HC-refiners?*. In International Mechanical Pulping Conference, IMPC 2014.
- He, J. , Engstrand, P. & Zhang, W. (2014). *Bio-SNG production in a TMP Mill in comparison with BIGCC*. In Energy Procedia. pp. 2894-2897.
- Walter, K. , Paulsson, M. & Engstrand, P. (2014). *Acid hydrogen peroxide treatment of Norway spruce TMP : The effect of chelated ferric ions*. In International Mechanical Pulping Conference, IMPC 2014.

## Surface and Colloid Chemistry

I studied chemistry as a major and received a PhD in physical chemistry in 1997. The research was about surfactants in solution, a joint collaboration between Umeå University and Mid Sweden University. My research interest today is still surface and colloid chemistry focused on surfactants and biomolecules and their functionality in aqueous solutions. The research is aiming at finding environmental solutions of the scientific issues.

During 2014, I was supervisor and co-supervisor for 7 PhD students, resulting in two doctoral degrees, one Licentiate degree and a number of publications.



Håkan Edlund

Professor of Physical Chemistry

Surface and Colloid Engineering

### Publications in 2014

- Zasadowski, D. , Strand, A. , Sundberg, A. , Edlund, H. & Norgren, M. (2014). *Selective purification of bleached spruce TMP process water by induced air flotation (IAF)*. *Holzforschung*, vol. 68: 2, ss. 157-165.
- Zasadowski, D. , Yang, J. , Edlund, H. & Norgren, M. (2014). *Antisolvent precipitation of water-soluble hemicelluloses from TMP process water*. *Carbohydrate Polymers*, vol. 113, ss. 411-419.
- Boija, S. , Almesåker, A. , Hedenström, E. , Bylund, D. , Edlund, H. & Norgren, M. (2014). *Determination of conditional stability constants for some divalent transition metal ion-EDTA complexes by electrospray ionization mass spectrometry*. *Journal of Mass Spectrometry*, vol. 49: 7, ss. 550-556.
- Svanedal, I. , Persson, G. , Norgren, M. & Edlund, H. (2014). *Interactions in Mixed Micellar Systems of an Amphoteric Chelating Surfactant and Ionic Surfactants*. *Langmuir*, vol. 30: 5, ss. 1250-1256.
- Svanedal, I. , Boija, S. , Norgren, M. & Edlund, H. (2014). *Headgroup interactions and ion flotation efficiency in mixtures of a chelating surfactant, different foaming agents and divalent metal ions*. *Langmuir*, vol. 30: 22, ss. 6331-6338.



- Duan, R. , Ibrahim, I. , Edlund, H. & Norgren, M. (2014). *Acid-Catalyzed Synthesis of Foamed Materials from Renewable Sources*. Industrial & Engineering Chemistry Research, vol. 53: 45, ss. 17597-17603.
- Norgren, M. & Edlund, H. (2014). *Lignin* : Recent advances and emerging applications. Current Opinion in Colloid & Interface Science, vol. 19, ss. 409-416.
- Svanedal, I. , Boija, S. , Almesåker, A. , Persson, G. , Andersson, F. , Hedenström, E. , Bylund, D. , Norgren, M. & et al. (2014). *Metal Ion Coordination, Conditional Stability Constants and Solution Behavior of Chelating Surfactant Metal Complexes*. Langmuir, vol. 30: 16, ss. 4605-4612.

## Forest as a resource

I was project leader for the research projects Forest as a Resource (FORE) and Miljöhorisont 2020 during 2014. The FORE-project ended 2014 and Miljöhorisont 2020 was a pre-study.

“FORE - Forest as a Resource” was a concept based on mechanical pulp production where we studied traditional and new fibre-based products produced in synergy with e.g. extraction of chemicals, bio-energy, synthesis gas, electricity or minerals. The FORE-project had six subprojects;

1. Uthållig produktion av skogsråvara
2. Biopolyvision
3. Återvinn
4. Biologiskt aktiva kemikalier
5. Energieffektiv produktion av nya produkter
6. Skogsindustriell förgasningsteknik



Erik Hedenström,

Professor of Organic Chemistry

Eco-chemistry

During 2014, I was supervisor for 7 PhD students, resulting in three doctoral degrees and a number of publications.

### Publications in 2014

- Wallin, E. , De Facci, M. , Anderbrant, O. & Hedenström, E. (2014). *(Z)-3-Dodecenoic Acid Is the Main Component of Full-Body n-Hexane Extracts from Two Acacia Gall-Inducing Thrips (Thysanoptera) and May Function as an Alarm Pheromone*. Zeitschrift für Naturforschung C - A Journal of Biosciences, vol. 69C: 7-8, pp. 335-345.
- Svensson, G. P. , Gündüz, E. A. , Sjöberg, N. , Hedenström, E. , Lassance, J. , Wang, H. , Löfstedt, C. & Anderbrant, O. (2014). *Identification, Synthesis, and Behavioral Activity of 5,11-Dimethylpentacosane, A Novel Sex Pheromone Component of the Greater Wax Moth, Galleria Mellonella (L.)*. Journal of Chemical Ecology, vol. 40: 4, pp. 387-395.
- Andersson, K. , Bergman, K. , Andersson, F. , Hedenström, E. , Jansson, N. , Burman, J. , Winde, I. , Larsson, M. C. & et al. (2014). *High-accuracy sampling of saproxylic diversity indicators at regional scales with pheromones: The case of Elater ferrugineus (Coleoptera, Elateridae)*. Biological Conservation, vol. 171, pp. 156-166.

- Karlsson, A. , Paulsson, M. , Engstrand, P. & Hedenström, E. (2014). *Strategies to reduce heat-induced darkening for enhanced bleachability of mechanical pulps*. Appita journal, vol. 67: 1, pp. 50-57.
- Boija, S. , Almesåker, A. , Hedenström, E. , Bylund, D. , Edlund, H. & Norgren, M. (2014). *Determination of conditional stability constants for some divalent transition metal ion-EDTA complexes by electrospray ionization mass spectrometry*. Journal of Mass Spectrometry, vol. 49: 7, pp. 550-556.
- Svanedal, I. , Boija, S. , Almesåker, A. , Persson, G. , Andersson, F. , Hedenström, E. , Bylund, D. , Norgren, M. & et al. (2014). *Metal Ion Coordination, Conditional Stability Constants and Solution Behavior of Chelating Surfactant Metal Complexes*. Langmuir, vol. 30: 16, pp. 4605-4612.
- Zauli, A. , Chiari, S. , Hedenström, E. , Svensson, G. P. & Carpaneto, G. M. (2014). *Using odour traps for population monitoring and dispersal analysis of the threatened saproxylic beetles *Osmoderma eremita* and *Elater ferrugineus* in central Italy*. Journal of Insect Conservation, vol. 18: 5, pp. 801-813.

## KM2 - large functional surfaces

KM2 means squarekilometres of areas that can be used for printing functionalities. During 2014, we have been working with several research projects developing knowledge about functional coatings on paper. The research projects are:

### COAT

In this research project we developed coating methods for nanomaterials on paper and related applications.

### KEPS

The research team behind Kinetic Energy Storage of Paper-Based Supercapacitors (KEPS) has demonstrated that graphene coated on paper could provide inexpensive as well as efficient supercapacitors.

### Modulit

This project aims to print energy storage devices such as supercapacitors on paper for printed electronics applications.

### Paper Solar Cells

Low-cost solar cells are needed. Manufacturing processes of today are mainly based on costly vacuum methods making solar electricity too expensive. Roll-to-roll processing is potentially a more efficient manufacturing method for solar cells.

### Smart street lights

We made a prestudy about off-grid street lights powered by solar cells and wind turbines. This project included demonstrators at campus Sundsvall.

During 2014, I supervised 4 PhD students. One doctoral and one licentiate degree were awarded.



Håkan Olin

Professor of Materials Physics

Materials Physics

### Publications in 2014

- Zhang, R. , Hummelgård, M. & Olin, H. (2014). *A facile one-step method for synthesising a parallelogram-shaped single-crystalline ZnO nanosheet*. Materials Science and Engineering: B, vol. 184, pp. 1-6.
- Andres, B. , Forsberg, S., Dahlström, C., Blomquist, N. & Olin, H. (2014). *Enhanced electrical and mechanical properties of nanographite electrodes for supercapacitors by addition of nanofibrillated cellulose*. Physica status solidi. B, Basic research, vol. 251: 12, pp. 2581-2586.
- Zhang, R., Andersson, H., Olsen, M., Hummelgård, M., Edvardsson, S., Nilsson, H. & Olin, H. (2014). *Piezoelectric gated ZnO nanowire diode studied by in situ TEM probing*. Nano Energy, vol. 3, pp. 10-15.
- Andersson, H. , Manuilskiy, A. , Haller, S. , Hummelgård, M., Sidén, J., Hummelgård, C., Olin, H. & Nilsson, H.E. (2014). *Assembling surface mounted components on ink-jet printed double sided paper circuit board*. Nanotechnology, vol. 25, 094002 (9 pp)
- Zhang, R. & Olin, H. (2014). *Porous Gold Films: A Short Review on Recent Progress*. Materials, vol. 7, ss. 3834-3854.

## New CTMP Technologies and effects of them

During 2014, I have been working with four research projects together with Gunilla Pettersson and Hans Höglund. All of them more or less focused on development of new technologies for TMP and CTMP paper industry.

In the project *“Low energy CTMP for paperboard”* funded by Knowledge foundation we gained useful knowledge on energy efficient production on spruce CTMP. HT technology (high-temperature) in combination with suitable refiner segments made it possible to achieve an energy reduction up to 40%. By adopting so called multilayer technology with addition of starch/CMC, it was proved that even very weak HT mechanical pulps can be used in high quality board production without compromising the end-use properties. The project was mostly carried out in pilot plant scale and as mill trials in cooperation with SCA Östrand and Stora Enso. The results in this project was presented in two speeches at the International Mechanical Pulping Conference in Helsinki in June 2014.



Sven Norgren
Dr., Researcher
High Yield Pulping Technology

Another project, *“Advanced HYP for paperboard”*, also funded by Knowledge Foundation started in 2014. The project goal is to develop and demonstrate techniques, based on hardwood (CTMP) particularly birch, to be used in manufacturing of paperboard. The total energy consumption in refining of such hardwood should be lower than 700 kWh/ton, to be compared with about 1200 kWh/ton in standard CTMP manufacturing. The CTMP should preferably be used for middle plies in a paperboard. At present a main obstacle to use birch CTMP in some paperboard qualities, e.g. liquid board, is a too high content of extractives. These causes problems with smell and taste from the packaging material. Improved technologies have to be developed to make birch CTMP an attractive complement to spruce CTMP for the paperboard industry.

In a project named *“SUPAHYP (Sustainable PACKaging High Yield Paper)”*, funded by Processum, we studied how to get significant improvement of in-plane strength. We are looking at the combined effects of energy efficient refining at temperatures well above the softening temperature of lignin, fibre surface modifications and sheet pressing technologies at higher than conven-



tional dry contents and temperatures. Improvements of in-plane strength and stiffness in sheets intended to be used in products with very high demands on strength, e.g. packaging paper and linerboard. The project are mostly carried out in pilot plant scale in cooperation with industrial partners, here MoRe Research and Stora Enso AB.

We have also been working in a project funded by Nils and Dorthi Troëdsson Research Foundation. In this project we intend to develop a process concept where the fibers in market pulps can have twice strength properties (tensile and Z-strength) than today conventional market pulp made of CTMP (wood yield about 90%). A successful outcome of the project may make it possible to compete successfully, with regarding both cost and quality, with chemical market pulp (wood yield about 50%) in manufacturing of paper products with such high strength requirements that today's high-yield pulp is not an interesting option.

To close, I have also been assistant supervisor to PhD student Sinke Henshaw Osong and worked with studies within the field of nano lingo cellulose.

## Publications

- Norgren, S. & Hoglund, H. (2014). *Consolidation of fibre-fibre bonds in TMP and CTMP based papers*. Paper Technology, vol. 55: 3, ss. 6-10.
- Norgren, S. Petterson, G. & Hoglund, H. (2014). *High strength papers from high yield pulps*. Paper Technology, vol. 56: 5, ss. 10-14.
- Pettersson, G. Hoglund, H. Norgren, S. Sjöberg, J. Peng, F. Hallgren, H. Moberg, A. Ljungqvist, C.H. Bergstrom, J and Solberg, D. (2014) *Strong and bulky paperboard from surface modified CTMP, manufactured at low energy*. Nordic Pulp & Paper Research Journal vol 30:2,
- Osong, S. H. , Norgren, S. & Engstrand, P. (2014). *Paper strength improvement by inclusion of nano-ligno-cellulose to Chemi-thermomechanical pulp*. Nordic Pulp & Paper Research Journal, vol. 29: 2, ss. 309-316.
- Osong, S. H. , Norgren, S. , Engstrand, P. , Lundberg, M. & Hansen, P. (2014). *Crill: A novel technique to characterize nano-ligno-cellulose*. Nordic Pulp & Paper Research Journal, vol. 29: 2, ss. 190-194.
- Osong, S. H. , Norgren, S. , Engstrand, P. , Lundberg, M. & Hansen, P. (2014). *Development of nano-ligno-cellulose produced from mechanical pulp*. I International Mechanical Pulping Conference, IMPC 2014.
- Norgren, S. , Pettersson, G. & Höglund, H. (2014). *High strength papers from high yield pulps*. I International Mechanical Pulping Conference, IMPC 2014. (International Mechanical Pulping Conference, IMPC 2014)
- Pettersson, G. , Höglund, H. , Sjöberg, J. C. , Peng, F. , Bergström, J. , Solberg, D. , Norgren, S. , Hallgren, H. & et al. (2014). *Strong and bulky paperboard plies from low energy CTMP*. I International Mechanical Pulping Conference, IMPC 2014.

## Pretreatment strategies of high yield pulps (e2mp)

In this project we study how chemical pretreatments influences the mechanical properties of wood and how this is related to refining conditions and pulp properties after refining. Sulphite pretreatment (sulphonation) was chosen since that is the most common pretreatment today.

The mechanical properties of sulphonated wood samples were tested using several testing techniques; shear, Split-Hopkinson and friction testing. The data from the mechanical testing was correlated to the properties of batch refined pulps.

Wood chips sulphonated at a low pH resulted in pulp with lower freeness and higher light scattering than chips sulphonated at alkaline pH despite lower energy input in the refining stage. Wood sulphonated at low pH (pH 4) is considerably stiffer (according to mechanical testing) than wood sulphonated at alkaline pH. A softer wood material was accompanied by a higher freeness in the resulting pulp.

We therefore suggest that knowledge about the mechanical properties of the pretreated material is important when discussing how to adjust the operating conditions such as plate gap, temperature, consistency and “intensity” when introducing new types of pretreated material in mechanical pulp refining.

### Papers accepted for publication during 2014

- Engberg, B.A., Logenius, L. and Engstrand, P. (2014): *Mechanical properties of sulphonated wood in relation to wing refiner properties*, Poster presentation, International Mechanical Pulping Conference, IMPC, Helsinki, Finland; 2-5 June
- Logenius, L., Fjellström, H. and Engstrand, P. O. (2014): *A sustainable analysis of sulphonic acid content in CTMP pulps* Poster presentation, International Mechanical Pulping Conference, IMPC, Helsinki, Finland; 2-5 June



Louise Logenius

Dr., Research engineer

High Yield Pulping Technology

*Nano-Ligno-Cellulose produced in our High Yield  
Pulping Technology laboratory at Mid Sweden  
University.*





Mittuniversitetet

MID SWEDEN UNIVERSITY

SE-871 88 Härnösand | SE-851 70 Sundsvall | SE-831 25 Östersund

[www.miun.se](http://www.miun.se)